

Translation of the Original Operating Manual

Masonry bench saw - MS 350C



**Read operating manual before starting any work!
Keep the operating manual for future use!**

Revision			
Date	Chapter	Reason for change	Person responsible
07-15		Reissue	Design
02-18		Revision	Design

Revision status: 02.2018
Serial number:

© Gölz GmbH
Dommersbach 51
D- 53940 Hellenthal

Tel.: +49 (0)2482 – 12 200
Fax: +49 (0)2482 – 12 222

Email: info@goelz.de
website: www.goelz.de

1 Content

1	Content	3
2	General	5
2.1	Operating manual	5
2.2	Symbols, acronyms, terminology	5
2.3	Explanation of symbols	5
2.4	Liability limitation	7
2.5	Customer service	7
2.6	Copyright	8
3	Safety	9
3.1	Intended use	9
3.2	Rationally foreseeable misuse	9
3.3	Responsibilities of the operator	10
3.4	Responsibilities of the personnel	10
3.5	Personnel requirements	11
3.6	Personal protective equipment	12
3.7	Dangers	12
3.7.1	Residual risks	12
3.7.1.1	Risks through mechanical hazards	12
3.7.1.2	Risks through electrical hazards	13
3.7.1.3	Risks through thermal hazards	13
3.7.1.4	Risks posed by special physical effects	14
3.7.1.5	Risks due to hazardous substances	14
3.7.1.6	Risks due to work environment conditions	14
3.8	Safety devices	14
3.9	Spare parts	15
3.10	Actions in emergency and in case of accidents	15
3.11	Signage	15
4	Technical data	17
4.1	Dimensions of the machine	17
4.2	Dimensions of the cut piece	17
4.3	Connection and motor values	17
4.4	Other data	17
4.5	Noise emission	17
4.6	Operating conditions	17
4.7	Cutting wheels	18
4.8	Type plate	18
4.9	Installation site requirements	18
4.10	Storage requirements	19
5	Design and function	20
5.1	Scope of delivery and responsibility	20
5.2	MS 350C	20
5.2.1	Functional description	22
6	Transport & packaging	23
6.1	Transport safety information	23
6.2	Transport inspection	23
6.3	Transport symbols	23
6.4	Transport and storage	24
7	Installation and first commissioning	26
7.1	Installation safety information	26
7.2	Location	26
7.3	Connection	27
7.4	First commissioning and acceptance, general	27

7.4.1	Steps before commissioning.....	27
7.4.1.1	Mounting a cutting wheel	27
7.4.1.2	Fill the water tank	28
8	Operation.....	29
8.1	Operation safety information.....	29
8.2	Intended working position of the operator	29
8.3	Start-up preparation	30
8.4	Start-up	30
8.5	Cutting operation	30
8.5.1	Normal cutting in 90° position	30
8.5.2	Cutting method: 45° bevel cuts.....	31
8.5.3	Water supply	31
8.6	Stop cutting operation	32
9	Maintenance & cleaning.....	33
9.1	Maintenance safety information.....	33
9.2	Maintenance plan	33
9.3	Description of the maintenance works to be carried out by the operator	34
9.3.1	Replacing the cutting wheel.....	35
9.3.2	Checking water supply line	35
9.3.3	Water pump and tank.....	35
9.4	Steps after completing maintenance	35
9.5	Parts susceptible to wear.....	35
10	Errors.....	37
10.1	Troubleshooting safety information	37
10.2	Actions in case of errors	37
10.3	Troubleshooting table	38
10.4	Steps after troubleshooting.....	40
11	Dismantling and disposal.....	41
11.1	Dismantling and disposal safety information	41
11.2	Dismantling	41
11.3	Disposal	41
12	Spare parts list.....	43
12.1	Using the spare parts list	43
12.2	Distribution agencies	43
	EU conformity declaration.....	46

2 General

2.1 Operating manual

This operating manual provides guidance on safe and efficient operation and should form a basis of any actions involving the machine. It is an integral part of the machine, which should be kept in the immediate vicinity accessible for its operating personnel.

Prerequisite of safe operation is adherence to all safety and handling instructions. Therefore, before starting any work, the personnel must read carefully and understand the operating manual.

Moreover, the accident prevention regulations applicable at the site of the machine operation and general safety regulations must be complied with.

2.2 Symbols, acronyms, terminology

Symbols, acronyms and specialist terminology used in this document have the following meaning:

	→	See item
	▶	Enumeration
	-	Enumeration
	1	Position number
	1.	Action step
<i>Text in italics</i>		Explanation of facts
		Refers to the document contained in the enclosed documentation. The source of the document is specified in italics behind the symbol.

2.3 Explanation of symbols

Warnings and safety instructions

Warnings and safety instructions in the manual are identified with the pictograms and provided in blocks highlighted in grey.

Warnings and safety instructions, which draw attention to fundamental dangers, are additionally precluded by signal words, which specify the scope of damage. Their structure is as follows:

SIGNAL WORD!
Origin of the danger.
Consequences of ignoring the danger.
- Actions to avoid danger

- ▶ All warnings and safety instructions must be implicitly complied with!
- ▶ During the works, always act with caution, to avoid accidents, personal and material damage!

Pictograms combined with signal words mean:



DANGER!

... draws attention to an immediate danger that, if not avoided, may result in heavy or even fatal injuries.



WARNING:

... draws attention to potentially dangerous situations that, if not avoided, may cause heavy or even fatal injuries.



CAUTION!

... draws attention to potentially dangerous situations that, if not avoided, may result in slight injuries.



ATTENTION!

... draws attention to potentially dangerous situations that, if not avoided, may result in material damage.

Tips and recommendations



NOTE!

... highlights tips and recommendations as well as information on efficient and trouble-free operation.

Special safety instructions

To make aware of special dangers, the following pictograms are used in combination with the safety instructions:



... marks danger due to electric current.

Failure to observe the safety instructions leads to danger of heavy or fatal injuries.



... marks danger of crushing.

Failure to observe the safety instructions leads to danger of heavy injuries from moving parts.



... marks danger due to hot surface.

Failure to observe the safety instructions leads to danger of burns and heavy skin injuries caused by heat.



... marks danger from moving cutting wheels.

Failure to observe the safety instructions leads to danger of cuts and heavy skin injuries caused by rotating cutting wheels.

2.4 Liability limitation

All data and instructions provided in this manual were compiled with consideration of applicable standards and regulations, state of the art in this field and our long-standing insights and experience.

The manufacturer accepts no liability for damages caused by:

- ▶ Non-observance of the Operating manual
- ▶ Unintended use
- ▶ Employment of unskilled and uninstructed personnel
- ▶ Unauthorised conversions
- ▶ Technical changes
- ▶ Use of non-approved spare parts

The responsibilities agreed in the delivery contract, the General Terms and Conditions as well as the delivery conditions of the manufacturer and the statutory regulations valid at the time of the conclusion of the contract shall apply.

Warranty

The manufacturer guarantees the functional capability of the applied process technology and performance parameters identified.

The warranty period commences with the defect-free delivery.

Wear parts

Wear parts are all parts having direct contact with the processed or machined material during normal operation.

These parts are excluded from warranty and defect claims, insofar as tear and wear resulting from normal operation.

Service life warranty

Service life warranty is granted for wear parts for the period of 6 months from the acceptance of the defect-free product.

Warranty conditions

12 months after delivery of mechanical and electrical components for one-shift operation, except for the wear parts and tools.

The warranty claim expires, if the system was not installed and started up by our experts.

The warranty extends to the replacement parts.

Consequential damages are excluded.

Damage caused by natural wear, deficient or improper maintenance, failure to comply with the operating regulations, excessive loads and use of inappropriate equipment shall be excluded from the warranty.

2.5 Customer service

Our customer service department is available to provide technical information.

Service hotline
02482 – 12 200

You can obtain tips via the regional competent contact person by phone or via fax, email or website at any time.

Moreover, our employees are interested in new information and experience arising from use and which can be valuable for the improvement of our products.

2.6 Copyright

This document is protected by copyright. An unauthorised transfer to third parties, duplication of any kind, including in parts, as well as use and/or disclosure of the content without written permission of the publisher is prohibited.

Non-compliance with this provision is subject to damages. The right for further claims remains reserved.

3 Safety

This section provides an overview of all safety aspects of protection of operators and users from potential dangers, and safe and trouble-free operation.
Disregarding these handling instructions, warnings and safety instructions may pose serious risks.

3.1 Intended use

The MS350C masonry bench saw is designed exclusively for the following purposes in the commercial sector:

The MS 350C masonry bench saw

- is designed for wet cutting of the solid construction materials such as: clinker, bricks, concrete block products, refractory, natural and artificial stone products as well as tiles and ceramics.



WARNING: Risk of unintended use!

Any use beyond the intended use of the machine may result in dangerous situations.

- The machine must be basically used for the intended purpose according to data contained in this document, in particular, within the application limits provided in the technical data.
- Refrain from any use beyond this scope or different use of the machine.
- Refrain from remodelling, refitting or changing the design or separate parts of the machine for the purpose of changing the field of application or applicability of the machine.

- ▶ Any claims for damages resulting from unintended use are excluded.
- ▶ The operator alone is responsible for all damages due to unintended use.

3.2 Rationally foreseeable misuse



WARNING: Risk of injury caused by misuse!

When misused, the machine may create dangerous situations for persons and cause heavy material damage.

- Refrain from any misuse of the machine.

Any use of the machine going beyond the intended one, shall be deemed unintended and thus prohibited.

This also applies to:

- cutting unauthorised construction materials, e.g., timber, metals, plastics
- cutting any materials other than presented
- cutting without or with open cutting wheel guard
- cutting without water
- removal of clippings in pendulum cutting procedure (vertical plunging into chippings from above)

3.3 Responsibilities of the operator

Operator

An operator is every natural or legal person, who uses the machine or delegates its use to others and is responsible for the safety of the user, personnel or third parties in the course of such use.

Operator's duties

The machine is used in the commercial sector. Therefore, the operator of the machine is subject to statutory obligations regarding occupational safety.

In addition to the warnings and safety instructions in this manual, the occupational safety, accident prevention and environmental protection regulations applicable to the field of the machine operation must be adhered to.

The operator, in particular, must:

- ▶ be informed about current occupational safety regulations,
- ▶ determine, through hazard evaluation, any potential additional dangers resulting from specific usage conditions at the site of the machine operation,
- ▶ put necessary behavioural requirements of the operating instructions into practice during the machine tool operation at the operation site,
- ▶ check regularly throughout the service life of the machine, whether the operating instructions drawn up by the operator are in line with the current status of rules and regulations,
- ▶ adjust the operating instructions, where necessary, to the new regulations, standards and operating conditions,
- ▶ exercise control of the competence for installation, operation, maintenance and cleaning of the machine in a clear and unambiguous manner,
- ▶ make sure that all personnel involved with the machine have read and understood the operating instructions. Moreover, the personnel must undergo training in handling the machine at regular intervals and be informed about potential dangers,
- ▶ provide the persons appointed for operating the machine with the prescribed and recommended protective devices.

Moreover, the operator is responsible for ensuring that the machine

- ▶ is always in a technically perfect condition,
- ▶ is maintained according to the specified maintenance intervals, and
- ▶ that all safety mechanisms of the machine are regularly controlled for completeness and functionality.

3.4 Responsibilities of the personnel

The machine is in the commercial use. Therefore, the personnel are subject to statutory obligations regarding occupational safety.

In addition to the warnings and safety instructions in this manual, the occupational safety, accident prevention and environmental protection regulations applicable to the field of operation must be adhered to.

In particular, the personnel must:

- ▶ be informed about current occupational safety regulations,
- ▶ adhere to behavioural requirements set out in the operating instructions issued at the site of the machine operation,
- ▶ properly exercise the responsibilities entrusted to them as regards installation, operation, maintenance and cleaning of the machine,
- ▶ fully read and understand the operating manual before starting work,
- ▶ use the prescribed and recommended protection equipment,

Moreover, scope of responsibility of every person operating the machine includes the duty of always

- ▶ keeping it in a technically perfect condition,
- ▶ performing maintenance, according to the intervals specified,
- ▶ controlling all safety mechanisms for completeness and functionality on a regular basis.

3.5 Personnel requirements

Fundamentals

Any operation with the machine may only be carried out by the persons, capable of performing their work properly and reliably and meet every requirement mentioned.

- ▶ No works can be carried out by the persons, whose response capability is affected, e.g., by drugs, alcohol or medicines.
- ▶ When deploying personnel at the site of operation, always adhere to the applicable occupational and age-specific regulations.

Qualification



WARNING:
Risk of injury for unqualified personnel!

Improper operation can result in significant personal and material damage.

- Any operations must be only carried out by the persons having required training, knowledge and experience.

Instructed personnel

Instructed personnel are the persons, who have been instructed by the operator on the tasks to be carried out and potential dangers in a detailed and verifiable way.

Specialist personnel

Specialist personnel are the persons, who, due to their professional training, knowledge and experience, as well as knowledge of the relevant provisions, are capable of duly carrying out the works assigned, recognise potential dangers independently and avoid personal and material damage.

Qualified electricians

As a matter of principle, all works on the electrical installations must be carried out by qualified electricians.

Qualified electricians are the persons, who, due to their specialist training, knowledge and experience, as well as knowledge of the relevant provisions, are capable of duly carrying out the works on electrical systems, recognising potential dangers independently and avoiding personal and material damage caused by electric current.

Unauthorised persons



WARNING:
Danger of injuries for unauthorised persons!

Those who have not been instructed are not aware of the dangers in the area of operation and must be considered unauthorised persons.

- Keep unauthorised persons away from the area of operation; if in doubt, address the persons met and banish them from the area of operation.
- Suspend operations until unauthorised persons leave the area of operation.

3.6 Personal protective equipment

Wearing personal protective equipment is required during the work.

- (1) Helmet with ear protectors
- (2) Visor or protective goggles
- (3) Dust mask / respirator
- (4) Safety gloves
- (5) Suitable protective clothing
- (6) Protective footwear with protection

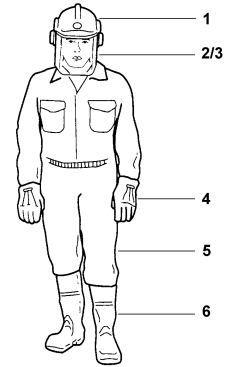

NOTE!

It is prohibited to wear protective gloves near rotating parts, which pose the danger of pinching. Here, danger created by wearing protective definitely surpasses the intended protection.

3.7 Dangers

The machine has undergone a risk review. Wherever possible, the identified dangers were eliminated and risks reduced. Nevertheless, the machine poses residual risks described in the following section.

- ▶ Strictly observe warnings and safety instructions specified here and in the chapters about handling to avoid potential damage to health and dangerous situations.

3.7.1 Residual risks

Even if used as intended, the machine may pose the following residual risks:

- ▶ Danger of finger and hand injury by the rotating tool.
- ▶ Injuries from flying workpieces in case of improper keeping or guiding.
- ▶ Injuries by snapped or ejected cutting disk or faulty diamond segment.
- ▶ Injuries resulting from touching live parts in case of opened or defective electric components.
- ▶ Hearing impairment due to long periods of work without hearing protection.

3.7.1.1 Risks through mechanical hazards

Rotating tools



CAUTION!
Risk of cut injuries!

Reaching into rotating tools may lead to heavy injuries.

- Do not touch rotating cutting wheels in any circumstances
- Never work without cutting wheel guard.
- Only work with cutting wheel guard closed
- Only remove clippings with cutting wheel stopped.

Flying clippings / tool



CAUTION!
Risk of injury by flying clippings or tool parts!

Failure to wear appropriate protective equipment, working with open cutting wheel guard or with inappropriate cutting wheels may lead to heavy injuries.

- Wear protective goggles
- Only work with cutting wheel guard closed
- Only work with cutting wheels, specifically designed for the material to be cut

Movable parts



CAUTION!
Risk of injury by pinching in movable parts!

Failure to wear appropriate protective equipment may lead to heavy injuries.

- Wear protective gloves
- Always fix the cutting table with transport lock
- Lock the cutter head

3.7.1.2 Risks through electrical hazards

Electric current



DANGER!
Danger to life from electric current!

Touching live parts leads to death. Damaged insulation or individual components can be life-threatening.

- Disconnect the machine from the power supply before any work on the electric system. Verify that the system is disconnected from power supply.
- Switch off power supply before maintenance, cleaning and repair operations and secure the machine against being restarted.
- If the power supply insulation is damaged, switch off immediately and arrange for repairs.
- Never bypass or disable fuses.
- Always use fuses with correct amperage when replacing defective fuses.
- Keep moisture away from live parts.
- Any works on the electrical installations must be carried out by qualified electricians.

3.7.1.3 Risks through thermal hazards

Hot surfaces



CAUTION!
Risk of burns on hot surfaces.

Contact with hot parts may cause burns.

- Do not touch the surface.
- Before every work, make sure that the parts have cooled down to the ambient temperature.

3.7.1.4 Risks posed by special physical effects



CAUTION!
Danger of injuries caused by special physical effects

Failure to wear appropriate protective equipment may lead to heavy injuries.

- Wear ear protectors
- Wear protective gloves
- Take adequate breaks
- Regular medical examinations 'G20'

3.7.1.5 Risks due to hazardous substances



CAUTION!
Risk of injury by hazardous substances, such as dust and cutting water or slurry!

Failure to wear appropriate protective equipment may lead to damage to health.

- Use personal protective equipment
- Renew the cutting water regularly
- Use the dust mask
- Connect water supply

3.7.1.6 Risks due to work environment conditions



CAUTION!
Risk of injury due to inadequate lighting.

Work in inadequate lighting conditions may lead to heavy injuries.

- Provide for adequate lighting at the workplace.

3.8 Safety devices



WARNING:
Danger to life due to defective or bypassed safety devices!

Inoperable, bypassed or disabled safety devices do not protect from hazards and may lead to heavy or fatal injuries.

- Before commencement of works, always make sure that all safety devices are properly installed and functional.
- Never disable safety devices.
- Ensure that the safety devices are always freely accessible.



NOTE!
See safety devices in → "Design and function".

Emergency stop switch

By pressing the emergency stop switch the machine is switched off (voltage free). Power supply is retained up to the switch. De-energize the machine by pulling out the mains plug. After an emergency stop and before switching on again eliminate the error that has occurred.

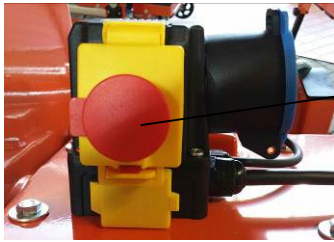

Emergency stop

3.9 Spare parts



WARNING: Risk of injury due to wrong spare parts.

Wrong spare parts can seriously compromise safety and cause damage and malfunction up to total failure.

- As a matter of principle, only original spare parts must be used.

Original spare parts can be obtained via an authorised dealer or directly from the manufacturer.

3.10 Actions in emergency and in case of accidents

Necessary actions

- ▶ Always be prepared for accidents or fire.
- ▶ First aid facilities (first aid box, cloth, etc.) and fire extinguisher must be close at hand.
- ▶ Personnel must familiarise themselves with accident signalling equipment, first aid and rescue facilities.
- ▶ Access roads for rescue vehicles must be always kept free.

If the need arises, act properly

- ▶ Activate emergency stop immediately
- ▶ Initiate first aid measures
- ▶ Remove persons affected from the danger area.
- ▶ Inform persons responsible at the operation site.
- ▶ Alert doctor and/or fire brigade in case of heavy injuries.
- ▶ Keep access roads for rescue vehicles free.

3.11 Signage

Danger of cutting damage



CAUTION! Risk of cut injuries!

Reaching into moving tools may lead to heavy injuries.

- Do not touch rotating cutting wheels in any circumstances
- De-energise the machine before replacing the cutting wheel

Danger from electric current!



DANGER! **Danger to life from electric current!**

Touching live parts leads to death. Damaged insulation or individual parts can be life-threatening.

- Disconnect the machine from the power supply before any work on the electric system. Check that no voltage is present!
- Switch off power supply before maintenance, cleaning and repair operations and secure the machine against being restarted.
- If the power supply insulation is damaged, switch off immediately and arrange for repairs.
- Never bypass or disable fuses.
- Always use fuses with correct amperage when replacing defective fuses.
- Keep moisture away from live parts.
- Any works on the electrical installations must be carried out by qualified electricians.
- Annual check of the electric system according to VDE0701.

Illegible signs



CAUTION! **Risk of injury due to illegible symbols!**

Stickers and signs that got illegible, make danger zones insufficiently recognisable and may become incapable of indicating potential injury risks.

- Always maintain legibility of pictograms, safety, warning and operating instructions.
- Immediately replace the pictograms, labels, signs or stickers that became illegible.

There are the following symbols and information signs on the machine that refer to potential dangers:

	<p>Warning of rotating tool!</p>	
	<p>Running direction of the saw blade</p>	
	<p>Wear gloves Wear ear protectors The machine meets EU guideline Observe the operating manual Wear protective goggles</p>	

4 Technical data

4.1 Dimensions of the machine

Specification	Value	Unit
Length	950	mm
Width	720	mm
Height	1260	mm
Empty weight	58	kg
Operating weight	79	kg

4.2 Dimensions of the cut piece

Specification	Value	Unit
max. length	380	mm
max. width	540	mm
max. height	105	mm
max. weight	10	kg

4.3 Connection and motor values

Specification	Value	Unit
Rated voltage	230/110	V
Rated frequency	50	Hz
Capacity	2,2	kW
Power input	10/20	A
Required fuse	16/29	A
Cutting shaft rotation speed	2800	Rpm
Motor protection class	IP55	
Motor duty type	S6	

4.4 Other data

Specification	Value	Unit
Water tank	20	l
Cutting wheel	350	mm
Bore	25,4	mm
Flange Ø	90	mm
Vibration level	2,3	m/s ²

Measuring tolerance	
Vibration level	0,2 m/sec ²

4.5 Noise emission

	Without load	Full load
Sound pressure level	76 dB (A)	89 dB (A)
Sound power level	78 dB (A)	91 dB (A)

Guaranteed sound power level	89 dB (A)
------------------------------	-----------

Measuring tolerance	
Sound pressure level	4 dB (A)
Sound power level	2.5 dB (A)

The data define the sound level of the noise exposure at the workplace of the operator and sound power level of the machine tool.

The emission values meet standards EN ISO 3744, EN 12418 and Directive 2005/88/EC.

4.6 Operating conditions

Working zone

Specification	Value	Unit
Temperature range	Ambient temperature 5-45	°C
Relative air humidity, maximum	60 (without condensing)	%
Conditions	Only operate the machine tool in the dust-free environment! Avoid direct impact of dampness, dust and frost. Do not operate in strong electric and magnetic fields! Do not operate the machine tool in explosive atmosphere!	

4.7 Cutting wheels

Cutting wheel	Cutting wheel diameter	Material	Number of segments	Segment height
SU50	Ø 350 mm	Concrete, washed concrete, bricks	28	10 mm
WRX1		Concrete, washed concrete, bricks, clinker, hard stone, granite	28	16 mm
SG35		Hard stone, granite, natural and artificial stone, hard clinker	30	10 mm



DANGER!
Risk of injury by defective or incorrectly mounted cutting wheels!

Wrong rotation direction and damaged cutting wheels may cause injuries of personnel!

- Check cutting wheels for broken off segments and segment pieces, segment foot cracks, cutting wheel deformations or signs of wear before starting work.
- Pay attention to the rotation direction arrows on the cutting wheel and guard!



DANGER!
Risk of injury by unchecked or unapproved tool!

Cutting wheels or buzz saw blades that have not been checked or approved may cause injuries of personnel!

- Before starting work, check whether a proper cutting wheel is mounted.
- Pay attention to the rotation direction arrows on the cutting wheel and guard!



NOTE!

All cutting wheels used must be designed in terms of their permissible max. cutting speed to match the max. drive speed and intended application of the machine tool.

4.8 Type plate

The type plate is located on the base frame of the machine tool.

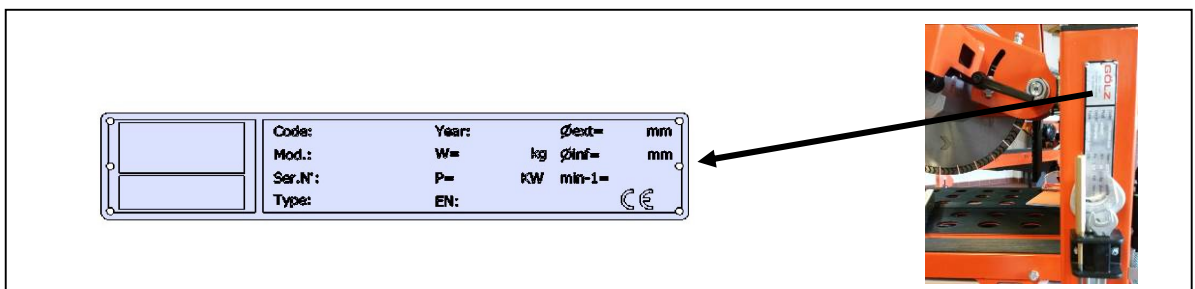

4.9 Installation site requirements

The floor surface must:

- ▶ have sufficient load bearing capacity,
- ▶ be slip proof,
- ▶ be level.

Installation conditions

- ▶ Choose the installation site as per space requirements according to the technical data.



NOTE!

The machine is designed for use in daylight. In case of work zones with poor or no lighting, ensure sufficient lighting of the workplace.

4.10 Storage requirements

Storage conditions

As a matter of principle, the machine, its components, assemblies or parts must be only stored in the following conditions:

- ▶ do not store outdoors
- ▶ store in dry and dust-free place
- ▶ do not expose to aggressive media
- ▶ protect from solar radiation
- ▶ avoid mechanical vibrations
- ▶ storage temperature range 5 to 45°C
- ▶ relative air humidity, max. 60%

In case of storage for over 3 months, check general condition of all parts and packaging on a regular basis. If necessary, renew or replace conservation materials.

5 Design and function

The machine consists of the base frame with pivotable main pillars and includes built-in systems, motor, cutting table, cutting wheel hood with a cutting wheel, and water tank with water pump.

5.1 Scope of delivery and responsibility

The machine was developed and manufactured under sole responsibility of Gölz GmbH.

Upon transfer to the operator, the responsibility for safe handling and instruction of the personnel passes to the operator.

The manufacturer offers training on the machine.

The scope of delivery includes the following components:

Components	Quantity
Masonry bench saw MS 350C	1
Technical documentation	1

Optional accessory	Quantity
Transport wheels main pillar	1
Cutting wedge 45°	1

5.2 MS 350C

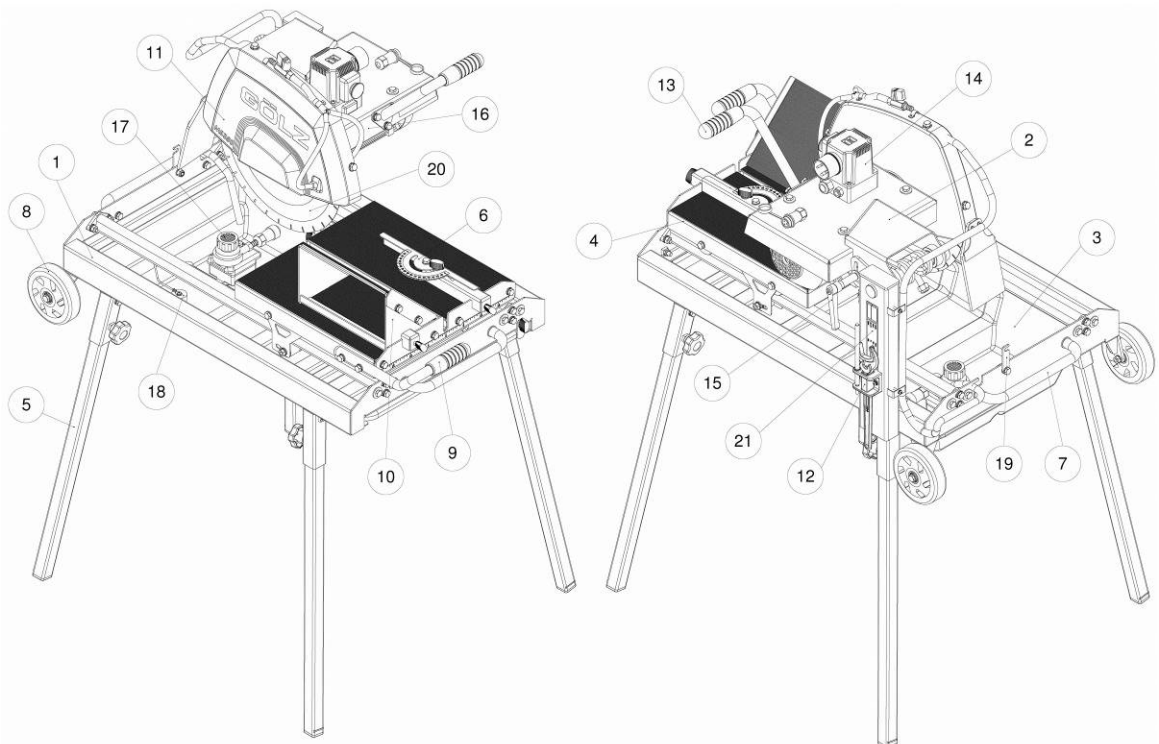

1	Base frame	8	Transport wheels	15	Adjusting handle
2	Cutter head	9	Table handle	16	Motor
3	Water tank	10	45° Cutting guide	17	Water pump
4	Cutting table	11	Blade guard	18	Drain plug
5	Main pillars	12	Tools shelf	19	Transport lock
6	Back square	13	Cutter head handle	20	Blade
7	Transport handle	14	Plug / switch (emergency stop & main switch)	21	Type plate

Base frame

The base frame (1) is a sturdy welded steel structure.

Cutter head

The cutter head is a welded steel structure, on the console of which the drive motor and cutting wheel guard are mounted. The cutter head weight is balanced by a tension spring.

The cutter head can be fixed by a locking lever (15) and thus enables accurate cuts to different depths. The cutter head handle (13) enables convenient cutter head setting.

Cutting wheel guard

The cutting wheel guard (11) protects from contact with the blade (20) and dangerous ejected parts. It must be always in place during operation! The cutting wheel guard can be opened to replace the cutting wheel. The rotation direction of the cutting wheel is shown on the hood by an arrow.

Cutting table

The cutting table (4) is an extraordinarily stable support table. Large openings enable water draining back to the water tank (3). To prevent fingers being trapped during transport, the cutting table can be fixed by a transport lock (19). The cutting table can be conveniently relocated using the mounted table handle (9).

Cooling water supply

An electric water pump (17) in the water tank (3) serves for cooling water supply and pumps the cooling water from the water tank to the blade (20). Sufficient water feed extends service life of the cutting wheel and dust suppression. Water feed can be regulated by a water tap on the cutting wheel guard. The water pump may never run dry. The water tank can be emptied by a drain plug (18).

E-motor and switch/plug combination

2.2kW electric motor. The motor is equipped with a thermal overload safety device that triggers if the motor is overheated. The machine can only be restarted after the motor temperature has dropped back to the operating temperature range.

Switch/plug combination with a built-in undervoltage release, which disables restarting the motor after a voltage failure. After a voltage failure, the machine must be restarted manually. The switch has an emergency stop function. If the emergency stop flap is pressed, the switch is locked, the motor is immediately de-energised and the machine comes to a halt. Restarting the machine is only possible after unlocking the emergency stop flap.



NOTE!

The constructively defined position of the emergency stop flap is directly above the main switch. Hitting on the external functional flap triggers an emergency stop. By opening the flap on this switch, the machine can be switched off by the main switch.



NOTE!

After the machine is switched on, the cutting wheel starts rotating immediately!

5.2.1 Functional description

The masonry bench saw is designed exclusively for cutting construction materials in the sizes provided in ->Technical data.

The operating personnel responsible manually place products onto the machine.

The cutter head is set to the desired cutting depth by the cutter head handle and locking lever. The cutter head handle is not intended for use in the cutting process.

The cutting table is only put into motion by the table handle.

By pressing the main switch, the electric motor of the machine is started and the cutting wheel starts turning immediately. Subsequently, the water feed must be turned on by the switch of the water pump located under the main switch. Water feed can be regulated by a water tap on the cutting wheel guard.

The material to be cut must be slid forward manually with the cutting table until the rear stop point of the cutting table is reached. The cutting process speed is regulated manually.

After cutting process is completed, switch off the motor by the main switch, and cut off the water feed by pressing the water pump switch.

6 Transport & packaging

6.1 Transport safety information



ATTENTION!
Damage through improper transportation!

Improper transportation can result in considerable damage of the transported goods and objects in the vicinity.

- Always act with utmost caution and care when loading and unloading transported goods.
- Pay attention to instructions and symbols on the packaging.
- Never remove transport locks earlier than before assembly.

6.2 Transport inspection

Inspect the condition of the transported goods immediately upon delivery for completeness and damage.

In the event of externally recognisable damages:

- ▶ do not accept the delivery or accept it only conditionally,
- ▶ record the scope of the damage in the transport documents and indicate it in the carrier's consignment note,
- ▶ lodge complaint.



NOTE!



*Claim any defect immediately upon delivery of the transported goods!
 Claims regarding transport damage can only be lodged within valid complaint periods.*

6.3 Transport symbols

On the outside of the transported goods, there are symbols corresponding to the content, which must be strictly observed during transportation and storage.

Meaning of the transport symbols

The following transport symbols can be placed on the transported goods:

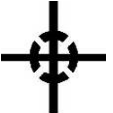
	<p>This side up</p> <p>The arrowheads indicate the top end of the transported goods. These should point upwards otherwise the content can be damaged.</p>		<p>Keep dry</p> <p>Protect the transported goods from dampness and keep them dry.</p>
	<p>Anchor point</p> <p>Only attach lifting tackle to the indicated points.</p>		<p>Centre of gravity</p> <p>Indicates the centre of gravity of the transported goods. Pay attention to the centre of gravity position when handling the goods!</p>

6.4 Transport and storage

Handling packaging

The machine is packed in a safe and environmentally sound manner for the anticipated transport conditions. The packaging protects the parts up to the beginning of assembly from damage and corrosion.

- ▶ Only remove packaging and transport locks before assembly.
- ▶ Dispose of packaging materials according to applicable local regulations.



ATTENTION! **Environmental damage through improper disposal!**

Packaging material is valuable raw material and can be used again or expediently reprocessed and recycled.

- Always dispose of packaging materials in an environmentally sound manner.
- Follow local regulations. If necessary, employ a specialised company for waste disposal.

Transport of the machine



ATTENTION! **Damage through improper transportation!**

Improper transportation can result in considerable damage of the machine and objects in the vicinity.

Before every transport:

- the cutting table must be secured by the table lock
- the cutter head must be lowered and locked
- the machine must be disconnected from power supply

Due to two transport rollers, the machine can be transported by one or two persons who can use transport handles.



NOTE!

The machine is not designed for crane transport. There are no appropriate load suspension points on the machine.

Storage of the machine

Store the machine in the following conditions:

- ▶ indoors only,
- ▶ store in dry and dust-free place,
- ▶ do not expose to aggressive media,

- ▶ protect from solar radiation,
- ▶ avoid mechanical vibrations,
- ▶ storage temperature: 5 to 45 °C,
- ▶ relative air humidity: max. 60%.
- ▶ In case of storage for over 3 months, check general condition of all parts and packaging on a regular basis. If necessary, renew or replace conservation materials.



NOTE!

*Store cutting wheels only vertically or suspended!
Protect from humidity!*

7 Installation and first commissioning

7.1 Installation safety information



WARNING!
Risk of injury due to improper installation!

Improper work performance and installation errors can result in heavy injuries during work and life-threatening situations during commissioning and operation.

- Any installation works must be only carried out by trained personnel authorised by the operator.
- Sufficient assembly freedom must be ensured before commencement of works.
- Always keep the working zone tidy and clean!



DANGER!
Danger to life from electric current!

Touching live parts leads to death. Damaged insulation or individual parts can be life-threatening.

- Connection, inspection and measurements of electric parts must be carried out by qualified electricians.
- In case of defective electric components switch off immediately and arrange for repairs.
- Keep humidity away from live parts.

7.2 Location

Find a suitable location to place the machine. Check secure footing before commissioning. Make sure that the cutting table is fixed by the transport lock. Using the adjustment screw, release the cutter head and lock it again in the bottom position.



- ▶ Loosen the star grip screws (2) and raise the machine by transport handles (1)
- ▶ Insert main pillars (3)
- ▶ To secure them, tighten firmly the star grip screws (2) again.

Personal protective equipment

- ▶ Protective clothing
- ▶ Protective gloves
- ▶ Safety shoes

7.3 Connection

Before connecting the machine to the power source, make sure that:

- ▶ voltage / phase of the power supply, match the date on the type plate of the motor and machine
- ▶ the power supply line is grounded according to the safety provisions
- ▶ the wire size of the extension cord is sufficient, H07RNF 3x2.5 mm² up to 50m for 230V



NOTE!
Power losses may occur if the cord length >50m!

Personal protective equipment

- ▶ Protective clothing
- ▶ Protective gloves
- ▶ Safety shoes
- ▶ Ear protectors
- ▶ Protective goggles

7.4 First commissioning and acceptance, general



DANGER!
Risk of injury during the first commissioning or adjustment works. Therefore:

- Before starting work, disable the machine and secure the machine against being restarted. Affix warning signs!
- Make sure that the machine is not placed on slopes or construction pits
- Make sure the surface is even
- Ensure sufficient lighting
- Keep environment clean and free from objects and cables
- Make sure, there are no unauthorised persons in the vicinity of the machine



The machine is delivered fully assembled. However, the blade, the transport handles, the transport wheels and the back square will have to be mounted. The main pillars must be unfolded.

7.4.1 Steps before commissioning

7.4.1.1 Mounting a cutting wheel

To mount a new cutting wheel or replace the used one, proceed as follows:

1. Switch off the machine and interrupt the power supply by pulling the mains cable from the mains outlet
2. Loosen the screws on the cutting wheel guard so as to be able to remove the front half of the cutting wheel guard
3. Loosen the nut of the motor shaft and remove the outer cutter flange

4. Clean the cutter flange, nut and motor shaft
5. Check the parts for signs of wear
6. Mount or replace the cutting wheel. While doing so, pay attention to the correct rotation direction of the cutting wheel and motor shaft



NOTE!
The arrow on the cutting wheel indicates correct rotation direction.

7. Replace the outer cutter flange on the motor shaft
8. Screw the nut onto the motor shaft again and tighten it firmly
9. Replace the front half of the cutting wheel guard to connect it with the rear half
10. Tighten firmly the screws on the cutting wheel guard



NOTE!
The cutting wheel, irrespective of its position or the position of the cutter head, may not touch the table!

7.4.1.2 Fill the water tank

The water tank must be filled before the machine is started. Use clear, clean water for this.



ATTENTION!
The water pump may not run without water, otherwise it can be damaged.



NOTE!
Pay attention to the remaining level of cooling and rinsing water, as well as cutting mud. These must be appropriately collected, filtered and disposed of.

8 Operation

8.1 Operation safety information



WARNING!

Risk of injury due to improper operation!

Improper operation may lead to heavy injuries.

- The machine may only be operated by trained personnel authorised by the operator.
- Before every work, make sure that the safety devices are correctly installed and function without flaws.
- Never disable safety devices.
- Always keep the working zone tidy and clean! Objects, parts, workpieces, tools and cleaning devices loosely lying around are accident sources.



DANGER!

Danger to life from electric current!

Touching live parts leads to death. Damaged insulation or individual parts can be life-threatening.

- In case of defective electric components switch off immediately and arrange for repairs.
- Keep humidity away from live parts.

Personnel

- ▶ Instructed personnel

Personal protective equipment

- ▶ Protective clothing
- ▶ Protective gloves
- ▶ Safety shoes
- ▶ Ear protectors
- ▶ Protective goggles

8.2 Intended working position of the operator

The operator takes position in front of the machine to be able to slide the cutting table forwards/backwards and to adjust the cutter head.



8.3 Start-up preparation

To safely use the machine as intended, the following preconditions must be met:

- ▶ the machine stands firmly
- ▶ the water tank is filled with clean, clear water
- ▶ the machine has been checked for damage, loose screw connections and integrity
- ▶ the water supply is functional
- ▶ rotation direction arrows on the cutting wheel and guard match
- ▶ an appropriate cutting wheel must be installed, which meets optimum conditions

8.4 Start-up

The machine is switched on by the main switch. press the green button to start.



NOTE!

After the start, check the following:

- The cooling water must be pumped to the cutting wheel by the water pump in the sufficient quantities and drain off on both sides.

If this is not the case, stop the machine immediately!

The motor is equipped with thermal insulation activated when the temperature rises too high.

Wait approx. 30 minutes before restarting the machine until the motor cools down.

8.5 Cutting operation

8.5.1 Normal cutting in 90° position

When used in 90° position, the cutter head is fixed in the lowest position.

For adjustment, proceed as follows.

1. Switch off the machine -> the cutting wheel must stop rotating!
2. Loosen the locking lever.
3. Press the cutter head down until depth stop.



NOTE!

The cutting wheel, irrespective of its position or the position of the cutter head, may not touch the table!

4. Tighten the locking lever -> make sure that the cutter head is fixed and cannot move.
5. Put the material to be cut onto the table and position it directly at the material stop.
6. Check the position of the material using the angle stop.
7. Start both motor and water pump.
8. Grab the handle of the cutting table by the left hand and the cutting head handle by the right hand.



NOTE!

In emergency, press the emergency stop button on the switch by the right hand.

9. Slowly slide the cutting table forward, without pressure, against the cutting wheel -> the cutting wheel will cut the laid material.

8.5.2 Cutting method: 45° bevel cuts

The machine offers the possibility of performing 45° bevel cuts.

To perform 45° bevel cuts, proceed as follows:

1. Switch off the machine -> the cutting wheel must stop rotating!
2. Pull the cutting table forward to free place for the cutter head.
3. Loosen the rear nut on the cutter head.
4. Tilt the cutter head until the 45° position is reached.
5. Tighten firmly the rear nut on the cutter head again.
6. Fix the cutter head with the locking lever in the lowest position.



NOTE!

The cutting wheel, irrespective of its position or the position of the cutter head, may touch neither the table, nor the back square!

7. Put the material to be cut onto the cutting table and position it directly at the material stop.
8. Check the position of the material using the back square.
9. Start the machine.
10. Grab the handle of the cutting table by the left hand and the cutting head handle by the right hand.



NOTE!

In emergency, press the emergency stop button on the switch by the right hand.

13. Slowly slide the cutting table forward, without pressure, against the cutting wheel, and pull it back after cutting through the material.

To bring the cutter head after this cutting procedure back to 90° position, proceed as follows:

1. Switch off the machine -> the cutting wheel must stop rotating!
2. Loosen the locking lever and fix the cutter head again in the top position.
3. Loosen the rear nut on the cutter head.
4. Tilt the cutter head until the 90° position is reached.
5. Tighten firmly the rear nut on the cutter head again.
6. Fix the cutter head by the locking lever again.



NOTE!

Hold firmly the cutter head with the hand in the 90° position. Tightening the nut can turn the square back so that the angle of the cutter head is not exactly 90°.



NOTE!

The cutting wheel, irrespective of its position or the position of the cutter head, may not touch the cutting table!

8.5.3 Water supply

Heavily polluted water decreases the service life of the water pump and cutting wheel.

- ▶ For frequent use, change water several times a day, and collect, filter and dispose of the cutting mud
- ▶ Clean the suction strainer of the water pump every time the water is changed

8.6 Stop cutting operation

To stop the machine, open the emergency cover of the switch and press the red button.



NOTE!

The constructively defined position of the emergency stop flap is directly above the main switch. Hitting on the external functional flap triggers an emergency stop. By opening the flap on this switch, the machine can be switched off by the main switch!

9 Maintenance & cleaning

9.1 Maintenance safety information



WARNING!

Risk of injury due to improper maintenance!

Improper maintenance may lead to injuries.

- Any maintenance works must be only carried out by instructed specialist personnel authorised by the operator.
- Sufficient assembly freedom must be ensured before commencement of works.



DANGER!

Danger to life from electric current!

Touching live parts leads to death. Damaged insulation or individual parts can be life-threatening.

- Switch off the electric system before maintenance and repair operations and secure it against being restarted.
- Keep humidity away from live parts.



WARNING!

Risk of injury due to wrong spare parts.

Wrong spare parts can seriously compromise safety and cause damage and malfunction up to total failure.

- As a matter of principle, only original spare parts must be used.



CAUTION!

Risk of cut injuries!

Reaching into moving tools may lead to heavy injuries.

- Do not touch rotating cutting wheels in any circumstances
- If any works need to be carried out, disconnect the machine from power supply

9.2 Maintenance plan

Maintenance works necessary for optimum and trouble-free operation are described in the following sections.

- ▶ If an increased wear of parts is revealed by regular inspections, reduce the maintenance intervals!
- ▶ Draw up a maintenance log after every maintenance! The log assists in error analysis, enables adjusting the intervals to actual usage conditions and validating guarantee claims.
- ▶ If you have any queries on maintenance works and intervals:
contact manufacturer.

Interval	Maintenance work	Personnel
----------	------------------	-----------

Before every commissioning	Visual check <ul style="list-style-type: none"> - of the entire machine - of the tool holder (flange and blade holder) - of the tool (cutting wheel) - of the control elements (handles, rollers, etc.) - of the water tank and hoses - of the cutter head and cutting table 	Operating personnel
	Visual check <ul style="list-style-type: none"> - of the electric system - of the motor - of the water pump 	Specialist personnel
	cleaning the tool holder (flange and blade holder)	Operating personnel
	checking the tool (cutting wheel) for replacement necessity	Operating personnel
	cutter head and cutting table <ul style="list-style-type: none"> - lubrication - greasing - oiling - applying corrosion protection 	Operating personnel
After completion of work	Cleaning of <ul style="list-style-type: none"> - entire machine - control elements (handles, rollers, etc.) - tools (cutting wheel) - cutter head and cutting table 	Operating personnel
	draining and cleaning water hoses and tank	Operating personnel
	Cleaning of <ul style="list-style-type: none"> - Motor housing - Water pump 	Specialist personnel
	tool holder (flange and blade holder) <ul style="list-style-type: none"> - lubrication - greasing - oiling - applying corrosion protection 	Operating personnel
weekly	Re-tightening and adjusting <ul style="list-style-type: none"> - control elements (handles, rollers, etc.) - cutter head and cutting table - threaded joints 	Operating personnel
yearly	Safety inspections of <ul style="list-style-type: none"> - electric systems - motor 	Qualified electricians
in case of an error	Visual check <ul style="list-style-type: none"> - of the entire machine - of the cutter head and cutting table 	Operating personnel
	Visual check <ul style="list-style-type: none"> - water pump 	Specialist personnel
	re-tightening and adjusting cutter head and cutting table	Operating personnel
in case of damage	change and replacement <ul style="list-style-type: none"> - entire machine - tool holder (flange and blade holder) - tools (cutting blade) - control elements (handles, locking rollers, etc.) - water tank and hoses - cutter head and cutting table 	Operating personnel
	change and replacement <ul style="list-style-type: none"> - electric systems - motor - Water pump 	Qualified electricians

9.3 Description of the maintenance works to be carried out by the operator



ATTENTION!

Cleaning by a high-pressure cleaner will damage the machine.

**ATTENTION!**

Foaming and cleaning with water will damage the machine.

ATTENTION!

The cutting wheel may not be cleaned by metal cleaning tools (scraper, metal sponge or similar), otherwise it will be damaged.

9.3.1 Replacing the cutting wheel

The cutting wheel must be replaced if:

- the diamond segments on the cutting wheel are fully worn, damaged or broken out
- varying materials are to be cut
- the cutting wheel does not rotate smoothly

9.3.2 Checking water supply line

Carry out acoustic and visual check for tightness of the connections and hoses after each work.

9.3.3 Water pump and tank

- Remove the polluted water.
- Remove mud deposits from the water tank bottom.
- Remove the water pump and put it into a bucket with clear water.
- Plug in the mains plug and let the machine run for approx. 1-2 minutes.
- Turn the machine off.
- Pull out the plug and insert the water pump again
-> thus avoiding obstruction of the pump wheel by the mud deposits.

9.4 Steps after completing maintenance

After completion of the maintenance works and before switching on, follow the following steps:

1. Check for tightness all threaded joints previously detached.
2. Check the proper installation of all previously removed protective devices and covers.
3. Make sure that all tools, materials and other equipment have been removed from the working zone.
4. Clean the working zone and remove any spilled substances such as liquids, processing materials or similar.
5. Make sure that all safety devices of the system function properly.

9.5 Parts susceptible to wear

Machine parts susceptible to wear are:

- Splash guard
- Hoses
- Slide bearings
- Spring
- Stopple
- Handle grip casing
- Guidance rollers
- Support rollers
- Rubber plates
- Pump housing with strainer
- Water pump
- Clutches
- Transport wheels
- Guiding rail
- Sticker
- Guiding rail
- Condenser
- Fan cover

Wear of these parts does not present any product defect.



NOTE!

Wear parts are highlighted in grey in the spare parts list!

10 Errors

10.1 Troubleshooting safety information



WARNING!

Risk of injury due to improper troubleshooting!

Improper actions in the course of troubleshooting may lead to heavy injuries.

- Any repair works must be only carried out by instructed specialist personnel authorised by the operator.
- Sufficient assembly freedom must be ensured before commencement of works.
- Always keep the working zone tidy and clean! Objects, parts, workpieces, tools and cleaning devices loosely lying around are accident sources.
- Check correct assembly of spare parts if these have been replaced. Fit properly all fastening elements. Observe screw tightening torques.
- Before recommissioning, make sure that all safety devices are properly installed and functional.



WARNING!

Risk of injury resulting from unauthorised restarting!

Personnel working on individual parts can be injured if the machine is restarted unexpectedly.

- Before working on any individual parts, switch off the machine and secure it against being restarted.



DANGER!

Danger to life from electric current!

Touching live parts leads to death. Damaged insulation or individual parts can be life-threatening.

- Switch off the electric system before maintenance and repair operations and secure it against being restarted.
- Keep humidity away from live parts.

10.2 Actions in case of errors

The following basically applies:

1. In case of errors posing an immediate danger for personnel or property, immediately activate the emergency stop.
2. Switch off power supply and secure it against being restarted.
3. Inform persons responsible at the operation site.
4. Depending on error reason type, assign responsible authorised specialist personnel to identify and eliminate it.

10.3 Troubleshooting table

Error message / error	Possible cause	Troubleshooting	Personnel
When switched on, the machine does not start	Mains plug is loose	Check proper connection to mains	Operating personnel
	Mains plug is defective	Check the mains plug for operability, replace if necessary	Qualified electricians
	Loose connection in the electric system	Have the entire electric system of the machine checked	
	The drive motor is defective	Have the drive motor checked, replace if necessary	
	The main switch is defective	Have the main switch checked, replace if necessary.	
The machine does not provide sufficient performance	The mains plug is too long, cord reel is wound up	Observe the prescribed length of the mains plug. Unwind the cable cord	Operating personnel
	Capacity of the local - mains is insufficient	Pay attention to and observe the machine connection data	
	The drive motor does not maintain the rotation speed	Have the drive motor checked, replace if necessary	Qualified electricians
Low or no cooling water feed	The water pump sucks air	Fill the tank with water; swivel the pump with the suction side downwards	Operating personnel
	Hose are clogged	Clean the hoses	
	Hoses bent	Check hose layout	
	A hose is leaky or detached	Replace or re-attach the hose properly	
	The water pump wheel or strainer is polluted	Clean the pump wheel or strainer	
	Water pump does not function	Have the electric supply line checked, replace if necessary	Qualified electricians
Motor does not start	Mains plug is not properly plugged.	Check the mains plug for proper connection	Operating personnel
	A fuse at the construction site - distribution board has tripped	Check fuses	
Cutting blade wobbles	Blade tension is poor	Return the cutting blade	Manufacturer
Segments are coming off	Overheating, cooling is poor	Check cooling water line	Operating personnel
		Segments are soldering on	Manufacturer

Error message / error	Possible cause	Troubleshooting	Personnel
High segment wear!	Segment bonding is too soft	Use cutting wheels with harder segments or reduce feeding pressure	Operating personnel
	Segments are too thin in relation to the motor capacity and feeding pressure	Reduce the feeding pressure, or use cutting - wheels with thicker segments	
	Segment number is too small	Use cutting wheels with segments, or reduce the - feeding pressure	
	The cutting wheel runs out	Use a new cutting wheel, have the old one straightened, check the cutting shaft, use a new one if necessary	
	The cutting wheel deviates	Check the table guides, replace if necessary	
	Abrasive aggregates	Use cutting wheels with harder segments	
	Feeding pressure is too high	Reduce the feeding pressure	
Cutting blade shows side and radial run-out	Cutting blade is bent or damaged	Have the cutting blade straightened, solder the segments to a new blade or use a new blade	Manufacturer
	Flange is polluted or damaged	Clean or replace the flange	Operating personnel
	Motor shaft is bent	Replace the electric motor	Qualified electricians
Zero performance when cutting, cutting blade is blunt	The cutting blade does not match the material	Use a proper cutting blade	Operating personnel
	The cutting blade does not match the machine capacity		
	The cutting blade is too hard		
	Diamond on the segment are blunt	sharpen	Specialist personnel
Suboptimal blade course	Blunt segments	sharpen	Specialist personnel
	Cutting blade is overloaded	Use an appropriate cutting blade	Operating personnel
	Poor tension of cutting blade	Return the cutting blade	Manufacturer
Mounting bore of the cutting blade is worn out	The cutting blade rotates on the motor shaft	Check the mounting flange, replace if necessary	Manufacturer
		The mounting bore must be hollowed out and a ring fitted in	Specialist personnel

Error message / error	Possible cause	Troubleshooting	Personnel
The cutting blade is oxide-coated	The cutting blade is overheating, too little cooling water	Check the cooling water	Operating personnel
	Lateral friction in the cut	Lower the feed rate, pull the material slowly	
Cracks on steel core; eccentric wear of the cutting blade	The cutting blade is too hard	Use a softer cutting blade	Operating personnel
	Motor shaft bearing	Replace the motor shaft bearing	

10.4 Steps after troubleshooting

After completion of the troubleshooting and before switching on, follow the following steps:

1. Check for tightness all threaded joints previously detached.
2. Check proper installation of all previously removed protective devices and covers.
3. Make sure that all tools, materials and other equipment have been removed from the working zone.
4. Clean the working zone and remove any spilled substances such as liquids, processing materials or similar.
5. Make sure that all safety devices of the machine function properly.

11 Dismantling and disposal

After the design service life is over, the machine must be dismantled and disposed of in an environmentally sound manner.

11.1 Dismantling and disposal safety information



WARNING!

Risk of injury resulting from improper dismantling!

Improper actions in the course of dismantling may lead to heavy injuries.

- Any dismantling works must be only carried out by instructed specialist personnel authorised by the operator.
- Sufficient assembly freedom must be ensured before commencement of works.
- Always keep the working zone tidy and clean! Objects, parts, workpieces, tools and cleaning devices loosely lying around are accident sources.
- Mind sharp-edged parts, corners and points.
- During dismantling operations, always secure parts so that cannot fall or overturn.
- Dismantle parts properly and in a professional way with consideration of local labour and environmental protection regulations.
- In cases of doubt, contact the manufacturer.



DANGER!

Danger to life from electric current!

Touching live parts leads to death.

Damaged insulation or individual parts can be life-threatening.

- Before dismantling operations, switch off power supply and secure the machine against being restarted.

Personnel

- ▶ Instructed specialist personnel authorised by the operator

11.2 Dismantling

1. Switch off the machine and secure it against being restarted.
2. Physically disconnect the power supply from the unit and discharge stored energy. Check that no voltage and pressure are present.
3. Remove operating and auxiliary materials, and remaining processing materials and dispose of them in accordance with the environmental regulations
4. Clean properly assemblies and parts, and disassemble them with consideration of the applicable local labour and environmental protection regulations.

11.3 Disposal

If no return or disposal agreement was made, send the dismantled components for recycling:

- ▶ scrap metal parts.
- ▶ hand over plastic parts for recycling.
- ▶ dispose of other components assorted according to material characteristics.

EU countries only

Electric waste is recyclable and must not be disposed of in the household waste!!
According to the European directive 2012/19/EU on electrical and electronic waste and version transposed into national law, used power tools must be collected separately and sent for recycling in an environmental-friendly manner.



ATTENTION!

Environmental damage resulting from improper disposal!

Wrong or negligent disposal may result in significant environmental pollution.

- Electrical scrap, electronic components, lubricants, operating and other auxiliary materials must be disposed of by specialised companies.
- In case of hazardous substances, treatment and disposal provisions of the material safety data sheets must be taken into consideration.
- In case of doubts, consult the manufacturer or local municipal authorities or specialised disposal companies on the environmentally safe ways of disposal.

12 Spare parts list

12.1 Using the spare parts list

The spare parts list is not a mounting or dismounting instruction. The only purpose of the spare parts list is to easily and quickly find spare parts which can be ordered with distribution agencies.



DANGER!

Risk of injury when mounting or dismantling assemblies!

Use of the spare part lists for mounting or dismantling may result in grave personal damage or death!

- During mounting or dismantling operations, relevant descriptions of the operating manual must exclusively be followed.

12.2 Distribution agencies

Deutschland - Germany - Allemagne - Duitsland

GÖLZ® GmbH
Dommersbach 51
DE-53940 Hellenthal
Tel: +49 (0)2482-12 200
Fax: +49 (0)2482-12 222
E-Mail: info@goelz.de / Internet: www.goelz.de

Österreich - Austria - Autriche - Oostenrijk

GÖLZ® Ges.m.b.H
Samstraße 52
A-5020 Salzburg
Tel: +43 (0) 662 - 43 81 75
Fax: +43 (0) 662 - 43 07 34
E-Mail: info@goelz.at / Internet: www.goelz.at

Frankreich - France - France - Frankrijk

GÖLZ® S.A.S.
1, rue de la Mairie
F-67370 Berstett
Tel: +33 (0)3.88.59.43.00
Fax: +33 (0)3.88.59.47.77
E-Mail: info@golz.fr / Internet: www.golz.fr

Großbritannien - Great Britain - Grande-Bretagne - Groot-Brittannië

GÖLZ® (UK) Ltd.
Unit A5, Springhead, Enterprise Park
Northfleet
Kent DA11 8HB
Tel: +44 1 474321679
Fax: +44 1 474321477
E-Mail: info@goelz.co.uk / Internet: www.goelz.co.uk

Benelux

GÖLZ® Benelux
Eupener Straße 61
BE-4731 Raeren-Eynatten
Tel: +49 (0)2482-12 200
Fax: +49 (0)2482-12 222
E-Mail: benelux@goelz.de / Internet: www.goelz-online.com

Australien - Australia - Australie - Australië

GOLZ® Pty Ltd.
44 Stanley Street
Peakhurst, NSW 2210
Tel: +61 (0) 2 9534 5599
Fax: +61 (0) 2 9534 5588
E-mail: info@golz.com.au / Internet: www.golz.com.au



USA

GOLZ® L.L.C.
5860 East Osage Ridge Lane
Columbia MO 65203-6018
Tel: +1 573 474 4961
E-Mail: info@golzusa.com / Internet: www.goelz-online.com



NOTE!

In order to avoid wrong deliveries the information the ordering information should be checked for accuracy and completeness before sending it! Completely indicate the delivery address!

		
<p>So bekommen Sie schnell und richtig Ihr Ersatzteil</p>	<p>Always indicate</p>	<p>Pour obtenir rapidement les pièces de rechange indiquer</p>
<ul style="list-style-type: none"> • Maschinentyp gemäß Typenschild • Baujahr gemäß Typenschild • Artikelnummer gemäß Ersatzteilliste • Maschinennummer gemäß Typenschild 	<ul style="list-style-type: none"> • machine type according to nameplate • year of manufacture according to nameplate • order number according to spare part list • serial number according to nameplate 	<ul style="list-style-type: none"> • type de la machine conforme de plaque d'identification • Année de construction selon plaque d'identification • Numéro de l'article selon la liste des pièces de rechange • numéro de la machine suivant plaque d'identification
<p>Für Bestellungen, Fragen und Informationen wenden Sie sich bitte an die zuständigen Stellen.</p>	<p>For orders, questions and information, please contact the competent departments.</p>	<p>Pour les commandes, questions et informations, veuillez-vous adresser aux points de ventes correspondants.</p>

13 Wiring diagram

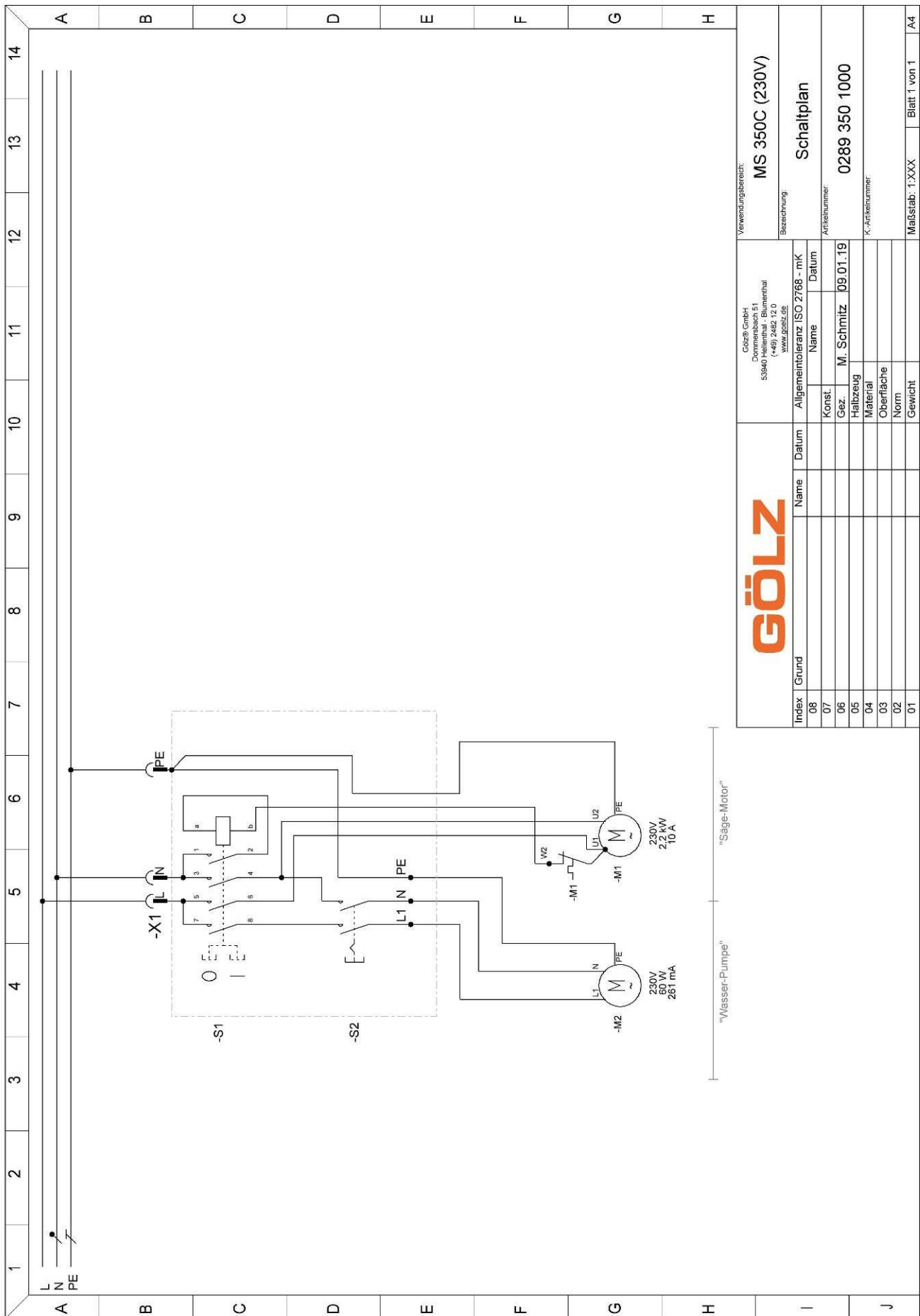

Verwendungsbereich:		MS 350C (230V)	
Bezeichnung:		Schaltplan	
Artikelnr.:		0289 350 1000	
K.-Artikelnr.:			
Maßstab: 1:XXX		Blatt 1 von 1 A4	
GöLZ® GmbH Dommersbach 51 53940 Heilenthal - Blumenhail (+49) 2482 12 0 www.golz.de		Allgemeintoleranz ISO 2768 - mK	
Index	Grund	Name	Datum
08	07		
06	05	M. Schmitz	09.01.19
04	03	Halbzeug	
02	01	Material	
		Oberfläche	
		Norm	
		Gewicht	

EU conformity declaration

GÖLZ® GmbH
 Dommersbach 51
 D-53940 Hellenthal
 Deutschland

declares under sole responsibility that

Model:	Masonry bench saw
Make:	GÖLZ
Type:	MS350C

comply with the relevant provisions of the Directives

2006/42/EC	Machinery directive
2014/30/EU	Electromagnetic compatibility
2014/35/EU	Low Voltage
2012/19/EU	Electrical and electronic waste
2011/65/EU	Restriction of the Use of Certain Hazardous Substances in Electrical and Electronic Equipment

and has been developed and fabricated in compliance with the following standards valid as at the production date:

DIN EN 12418:2022-07	Masonry and stone cutting-off machines for job site - Safety
DIN EN ISO 12100:2011-03	Safety of machinery - General principles for design
DIN EN ISO 13849-1:2023-12	Safety of machinery - Safety-related parts of control systems
DIN EN 61000-3-2:2019+A1 DIN EN 61000-3-11:2019	Electromagnetic compatibility
DIN EN 55014-1:2021 DIN EN 55014-2:2021	Electromagnetic Compatibility
DIN EN 60204-1; VDE 0113-1:2019-06	Safety of machinery - Electrical equipment of machines

Technical documentation kept by:

GÖLZ® GmbH
 Development and design

Year of construction and machine number are indicated on the unit.

.....
 Managing Director