

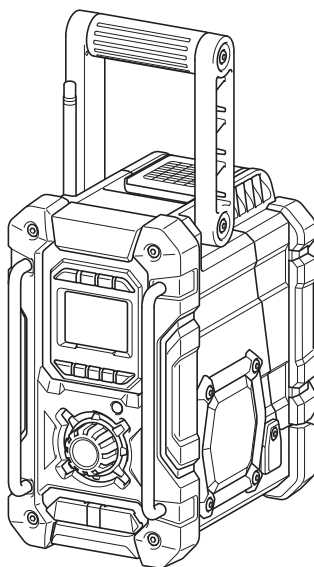

Job Site Radio

DMR108



INSTRUCTION MANUAL

IMPORTANT: Read Before Using.

ENGLISH (Original instructions)

Symbols

The following show the symbols used for the equipment. Be sure that you understand their meaning before use.



Read instruction manual.



Only for EU countries

Do not dispose of electric equipment or battery pack together with household waste material!

In observance of the European Directives, on Waste Electric and Electronic Equipment and Batteries and Accumulators and Waste Batteries and Accumulators and their implementation in accordance with national laws, electric equipment and batteries and battery pack(s) that have reached the end of their life must be collected separately and returned to an environmentally compatible recycling facility.

IMPORTANT SAFETY INSTRUCTIONS

WARNING:

When using electric tools, basic safety precautions should always be followed to reduce the risk of fire, electric shock, and personal injury, including the following:

1. Read this instruction manual and the charger instruction manual carefully before use.
2. Clean only with dry cloth.
3. Do not install near any heat sources such as radiators, heat registers, stoves, or other apparatus (including amplifiers) that produce heat.
4. Only use attachments/accessories specified by the manufacturer.
5. Unplug this apparatus during lightning storms or when unused for long periods of time.
6. A battery operated radio with integral batteries or a separate battery pack must be recharged only with the specified charger for the battery. A charger that may be suitable for one type of battery may create a risk of fire when used with another battery.
7. Use battery operated radio only with specifically designated battery packs. Use of any other batteries may create a risk of fire.
8. When battery pack is not in use, keep it away from other metal objects like: paper clips, coins, keys, nails, screws, or other small metal objects that can make a connection from one terminal to another. Shorting the battery terminals together may cause sparks, burns, or a fire.
9. Avoid body contact with grounded surfaces such as pipes, radiators, ranges and refrigerators. There is an increased risk of electric shock if your body is grounded.
10. Under abusive conditions, liquid may be ejected from the battery; avoid contact. If contact accidentally occurs, flush with water. If liquid contacts eyes, additionally seek medical help. Liquid ejected from the battery may cause irritation or burns.

SAVE THESE INSTRUCTIONS.

SPECIFIC SAFETY RULES FOR BATTERY CARTRIDGE

1. Before using battery cartridge, read all instructions and cautionary markings on (1) battery charger, (2) battery, and (3) product using battery.
2. Do not disassemble battery cartridge.
3. If operating time has become excessively shorter, stop operating immediately. It may result in a risk of overheating, possible burns and even an explosion.
4. If electrolyte gets into your eyes, rinse them out with clear water and seek medical attention right away. It may result in loss of your eyesight.
5. Do not short the battery cartridge:
 - (1) Do not touch the terminals with any conductive material.
 - (2) Avoid storing battery cartridge in a container with other metal objects such as nails, coins, etc.
 - (3) Do not expose battery cartridge to water or rain. A battery short can cause a large current flow, overheating, possible burns and even a breakdown.
6. Do not store the tool and battery cartridge in locations where the temperature may reach or exceed 50°C (122°F).
7. Do not incinerate the battery cartridge even if it is severely damaged or is completely worn out. The battery cartridge can explode in a fire.
8. Be careful not to drop or strike battery.
9. Do not use a damaged battery.
10. To avoid risk, the manual of replaceable the battery should be read before use.
And the max discharging current of the battery should be greater than or equal to 8A.

CAUTION:

- Danger of explosion if battery is incorrectly replaced.
- Replace only with the same or equivalent type.

Explanation of general view

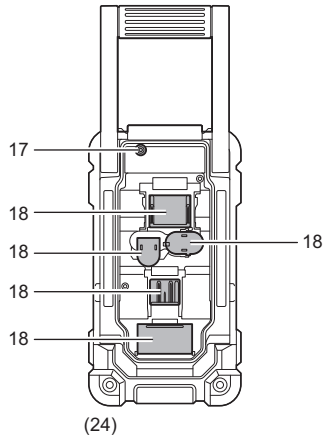
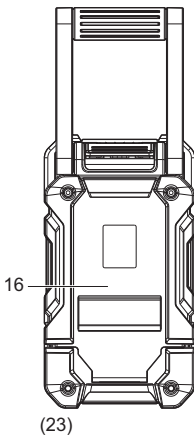
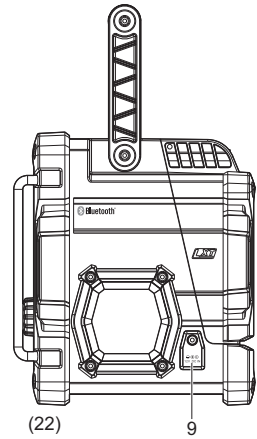
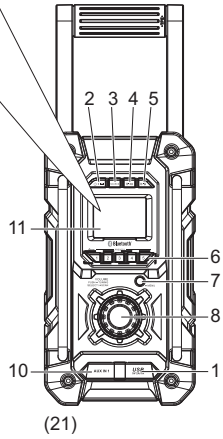
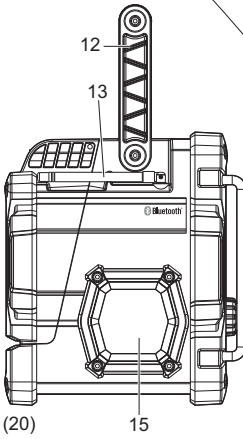
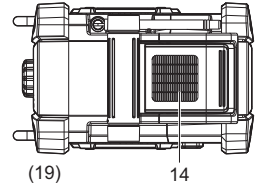
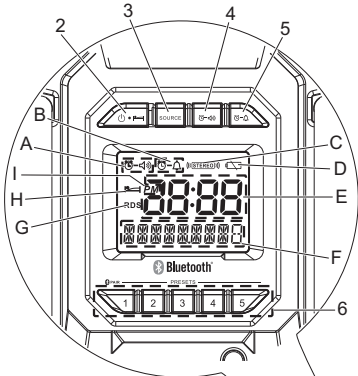

1. USB power supply port
2. Power/Sleep timer
3. Source button
4. Radio alarm
5. Buzzer alarm
6. Preset stations/Preset 1 button as Bluetooth® pair button
7. Menu/Info button
8. Volume/Tuning control/Select knob
9. DC IN socket
10. AUX IN 1
11. LCD display
12. Handle
13. Soft bended rod antenna
14. Battery compartment locker
15. Speaker
16. Battery cover
17. Input terminal (AUX IN 2)
18. Battery compartment (covering main battery pack and back up batteries)
19. Up
20. Left
21. Front
22. Right
23. Back; Battery cover closed
24. Back; Battery cover opened
25. Battery cartridge
26. Button
27. Indicator lamps
28. Check button

LCD display:

- A. Radio alarm
- B. Buzzer alarm
- C. Stereo symbol
- D. Low battery indicator
- E. Clock
- F. Frequency
- G. RDS (Radio data system)
- H. Sleep status
- I. AM/PM for clock

Battery Installation

Note:

Keeping back up batteries inside the compartment prevent stored data in preset memories from being lost.

Back up battery Installation

1. Pull out the battery compartment locker to release battery compartment. There are main battery pack compartment and back up battery compartment.

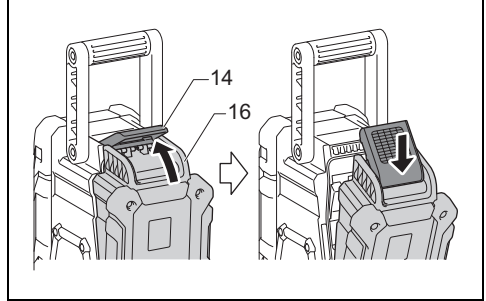

2. Remove back up battery compartment cover and insert 2 fresh UM-3 (AA sizes). Make sure the batteries are with correct polarity as shown inside the compartment. Replace the battery cover.

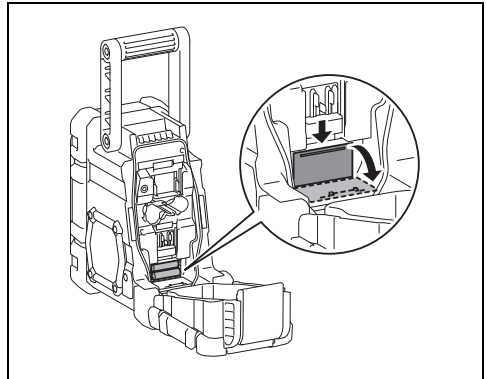

3. After back up batteries are inserted, insert the main battery pack to power radio. The suitable battery packs for this radio listed as the following table.

The following table indicates the operating time on a single charge in Radio mode.

Battery capacity	Battery Cartridge Voltage				At speaker output = 50 mW + 50 mW (unit: Hour) (Approximately)	
	7.2 V	10.8 V	14.4 V	18 V	In radio or AUX	In Bluetooth® with USB charging
1.0 Ah	BL7010				7.0	0.8
1.3 Ah		BL1013			8.5	1.5
			BL1415	BL1815	9.0	2.0
1.5 Ah		BL1015			9.5	1.8
			BL1415N		10	2.0
				BL1815N		2.5
2.0 Ah		BL1020B			13	2.5
				BL1820/ BL1820B	14	3.5
3.0 Ah			BL1430/ BL1430B		20	4.5
				BL1830/ BL1830B	21	5.0
4.0 Ah		BL1040B			26	5.0
			BL1440		27	6.0
				BL1840/ BL1840B	28	7.0
5.0 Ah			BL1450		34	8.0
				BL1850/ BL1850B	35	8.5
6.0 Ah			BL1460B		37	8.5
				BL1860B	42	10

 : Cluster Battery

 : Slide Battery

Note:

Table regarding to the battery operating time above is for reference. The actual operating time may differ with the type of the battery, charging condition, or usage environment.

Installing or removing Slide battery cartridge

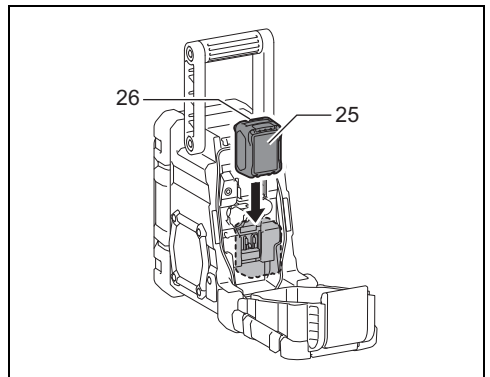
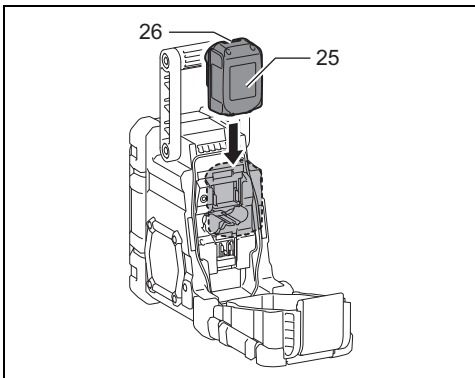

- To install the battery cartridge, align the tongue on the battery cartridge with the groove in the housing and slip it into place. Always insert it all the way until it locks in place with a little click.

- If you can see the red indicator on the upper side of the button, it is not locked completely. Install it fully until the red indicator cannot be seen. If not, it may accidentally fall out of the tool, causing injury to you or someone around you.
- Do not use force when inserting the battery cartridge. If the cartridge does not slide in easily, it is not being inserted correctly.
- To remove the battery cartridge, withdraw it from the tool while sliding the button on the front of the cartridge or pressing the buttons on both sides of the cartridge.

Installing or removing Cluster battery cartridge

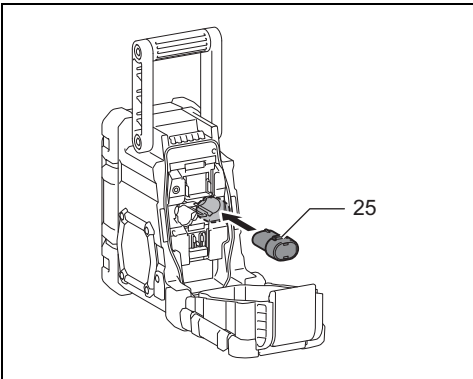
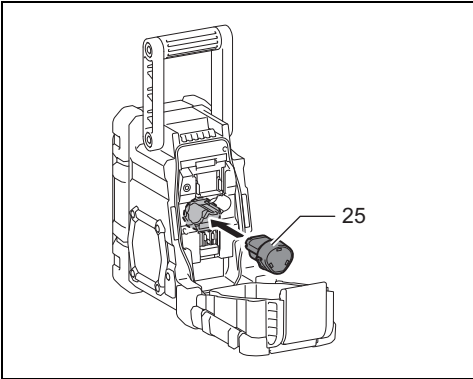

- To insert the battery cartridge, align the tongue on the battery cartridge with the groove in the housing and slip it into place.
- To remove the battery cartridge, take the battery out of the terminal while pressing the buttons on the side of cartridge.

Return the battery compartment locker to the original position.

Reduced power, distortion, "stuttering sound" or when both low battery sign  and "POWERFAIL" appear on

the display are all the signs that the main battery pack needs to replace.

Note:

The battery pack can't be charged via the supplied AC power adaptor.

When low battery sign  appears and an "EMPTY" keeps on flashing is the time to replace the back up batteries.





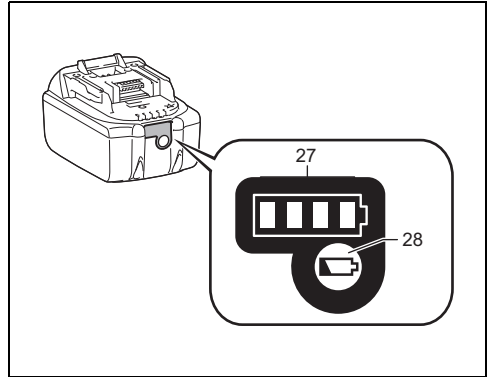







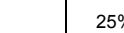

Indicating the remaining battery capacity

Only for battery cartridges with "B" at the end of the model number



015676

Press the check button on the battery cartridge to indicate the remaining battery capacity. The indicator lamps light up for few seconds.

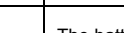
Indicator lamps			Remaining capacity
 Lighted	 Off	 Blinking	
			75% to 100%
			50% to 75%
			25% to 50%
			0% to 25%
			Charge the battery.
 	 		The battery may have malfunctioned.

015658

Note:

- Depending on the conditions of use and the ambient temperature, the indication may differ slightly from the actual capacity.

Using the soft bended rod antenna

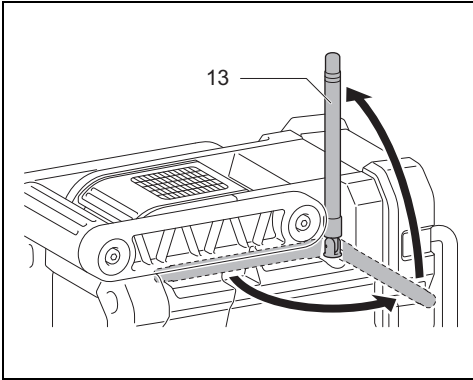

Straight up the soft bended rod antenna as shown in the figure.

Using Supplied AC power adaptor

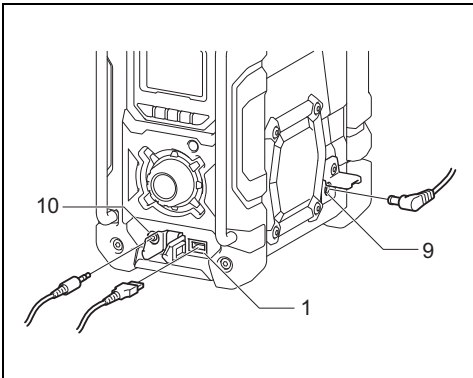



Remove the rubber protector and insert the adaptor plug into the DC socket on the left side of the radio. Plug the adaptor into a standard mains socket outlet. Whenever the adaptor is used, the battery pack is automatically disconnected. The AC adaptor should be disconnected from the main supply when not in use.



Note:

When your radio has any interference in AM band by its adaptor, please move your radio away from its AC adaptor over 30 cm.

Operating your radio – Scan tuning AM/FM

1. Press the Power button  to switch on your radio.
2. Press the Source button  to select AM or FM radio mode.
3. Press and hold the Tuning control knob  to carry out an auto-tune. Your radio will scan up the AM/FM band from the currently displayed frequency and will stop

scanning automatically when it finds a station of sufficient strength.



4. After a few seconds the display will update. The display will show the frequency of the signal found.
5. To find other station, press and hold the Tuning control knob  as before.
6. When the end of the waveband is reached your radio will recommence tuning from the opposite end of the waveband.
7. Rotate the Tuning control knob  to adjust the sound level as required.

Note:



- While adjusting the volume, make sure the FM/AM is NOT flashing on the screen.
- If AM/FM is flashing on the screen, it allows you to tune the stations manually (see the section of “Manual tuning – AM/ FM” for more detail).

8. To switch off your radio press the Power button .

Manual tuning – AM/FM

1. Press the Power button  to switch on your radio.
2. Press the Source button  to select AM or FM radio mode.
3. Press the Tuning control knob  and you will see the FM or AM is flashing on the display.



Note:

- FM/AM will flash approx. 10 seconds. Within this period, only manual tuning is allowed.
 - If volume adjustment is desired while FM/AM is flashing, press the Tuning control knob to stop the flash and you can rotate the Tuning control knob to adjust sound level.
4. Rotate the Tuning control knob  to tune to a station.
 5. When the end of the waveband is reached your radio will recommence tuning from the opposite end of the waveband.
 6. Use the Tuning control knob  to adjust the sound level as required.

Presetting stations in AM/FM mode

There are 5 preset stations each for AM and FM radio.

They are used in the same way for each waveband.

1. Press the Power button  to switch on your radio.
2. Press the Source button  to select the desired waveband. Tune to the required radio station as previously described.
3. Press and hold the required Preset button (1 to 5)  until the display shows “P4” for example after the frequency. The station will be stored using the preset number. Repeat this procedure for the remaining presets as you wish.

4. Preset stations which have already been stored may be overwritten by following the above procedure if required.



Display modes – FM

Your radio has a range of display options for FM radio mode.



1. Repeatedly press the Menu/Info button  to view the RDS information of the station you are listening to.
 - a. Station name Displays the name of the station being listened to.
 - b. Program type Displays the type of station being listened to such as Pop, Classic, News, etc.
 - c. Radio text Displays radio text message such as new items etc.
 - d. Year/Day Displays the year and day of the week according to the date setting of your radio.
 - e. Date/Day Displays the date and day of the week according to the date setting of your radio.
 - f. Frequency Displays the frequency of the FM for the station listened to.

FM stereo (auto)/mono

If the FM radio station being listened to has a weak signal some hiss may be audible. It is possible to reduce this hiss by forcing the radio to play the station in mono rather than stereo.

1. Press the Power button  as needed to select the FM band and tune to the desired FM station as previously stated.
2. Press and hold Menu/Info button  to enter the menu setting.
3. Rotate the Tuning control knob  until the FM Auto/mono setting shows on the display. If the setting is Auto press the Tuning control knob to switch to Mono mode to reduce the hiss. Press the Tuning control knob to select the option.





Recalling a preset in AM/FM mode





1. Press the Power button  to switch on your radio.
2. Press the Source button  to select AM or FM radio mode.
3. Momentarily press the required Preset button  to cause your radio to tune to one of the stations stored in the preset memory.

Clock and Alarms















Setting the time and date format

The clock display used in stand-by mode and on the playing mode screens can be set to different format. The selected format is then also used when setting the alarms.

1. Press and hold the Menu/Info button  to enter the menu setting.
2. Rotate the Tuning control knob  until "CLOCK xxH" appears on the display and press the Tuning control knob  to enter the setting. You will see the time format begins to flash.
3. Rotate the Tuning control knob  to select either 12 or 24 hour format. Press the Tuning control knob  to confirm your choice of clock format.



Note: If the 12 hour clock format is chosen, the radio will then use the 12 hour clock for the setting.
4. Press and hold the Menu/Info button  to enter the menu setting.
5. Rotate the Tuning control knob  until a date (e.g. THU APR 3) appears on the display and press the Tuning control knob  to enter the setting. You will see the date format begins to flash.
6. Rotate the Tuning control knob  to select the desired date format. Press the Tuning control knob  to confirm your choice.



Setting the clock time and date

1. Press and hold the Menu/Info button .
2. Rotate the Tuning control knob  until "CLOCK ADJ" appears on the display. Press the Tuning control knob  to enter the setting.
3. The hour setting on the display will begin flashing. Rotate the Tuning control knob  to select the desired hour, and press the Tuning control knob  to confirm the setting. Then rotate the Tuning control knob  to select the desired minute, and press the Tuning control knob  to confirm the setting.
4. Rotate the Tuning control knob  until "DATE ADJ" appears on the display. Press the Tuning control knob  to enter the setting.
5. Rotate the Tuning control knob  to select the desired year and press the Tuning control knob  to confirm the setting. Then rotate the Tuning control knob  to select the desired month, and press the Tuning control knob  to confirm the setting. Then rotate the Tuning control knob  to select the desired date and press the Tuning control knob  to confirm the setting.

Radio Data System (RDS)

When you set the clock time using the RDS function, your radio will synchronize its clock time whenever it tunes to a radio station using RDS with CT signals.







1. When tuning to a station transmitting RDS data, press and hold the Menu/Info button .
2. Rotate the Tuning control knob  until "RDS CT" and a clock symbol appear on the display. Press the Tuning control knob  to enter the setting.

3. Rotate the Tuning control knob  until "RDS CT" appears on the display. Press the Tuning control knob  to confirm the setting. The clock time of the radio will set up automatically according to the RDS data received.
4. When the action is completed, the RDS icon will appear on the LCD display indicating the radio time is RDS clock time. The radio clock time will be valid for 5 days each time the radio time is synchronized with RDS CT.

Setting the alarm clock

Your radio has two alarms which can each be set to wake you to AM/FM radio or buzzer alarm. The alarms may be set while the unit is in standby mode or while playing.

a. Setting radio alarm time:

1. The radio can be set either when radio is on or off.
2. Press and hold the radio alarm button , the radio alarm symbol and the display hour will flash along with a beep.
3. During radio alarm symbol  flashes, rotate Tuning control knob  to select the hour and press Tuning control knob  again to confirm hour setting. Then rotate the Tuning control knob  to select the minute and press Tuning control knob  to confirm minute setting.
4. Rotate the Tuning control knob and the display will show the frequency options for the alarm.
The alarm options are as follows:
ONCE – the alarm will sound once
DAILY – the alarm will sound everyday
WEEKDAY – the alarm will sound only on weekdays
WEEKEND – the alarm will sound only at weekends
Press the Tuning control knob  to confirm the setting.
5. During radio alarm symbol is flashing, rotate Tuning control knob to select desired wake-up band and station, then press Tuning control knob to confirm the selection.
6. Rotate Tuning control knob to select the desired volume and press Tuning control knob to confirm the volume. Radio alarm setting is now completed.

Note:

If new radio alarm station is not selected, it will select the last alarm station.







Note:

If the selected AM/FM alarm station is not available when the alarm is sounding, the buzzer alarm will be used instead.

b. Setting HWS (Humane Wake System) buzzer alarm:

A beep tone will activate when selecting the HWS buzzer alarm.

The alarm beep will sound shorter every 15 seconds for one minute followed by one minute silence before repeating the cycle.

1. The buzzer alarm can be set either when the radio is on or off.
2. Press and hold the buzzer alarm button , the symbol and the display hour will flash along with a beep.
3. During buzzer alarm symbol  flashes, rotate Tuning control knob  to select the hour and press Tuning control knob  again to confirm hour setting. Then rotate the Tuning control knob  to select the minute and press Tuning control knob  to confirm minute setting.
4. Rotate the Tuning control knob and the display will show the frequency options for the alarm.
The alarm options are as follows:
ONCE – the alarm will sound once
DAILY – the alarm will sound everyday
WEEKDAY – the alarm will sound only on weekdays
WEEKEND – the alarm will sound only at weekends
Press the Tuning control knob  to confirm the setting.

Note:

There is no volume adjustment for buzzer alarm.

When the alarm sounds

To cancel a sounding alarm, press the Power button









Disabling/cancelling alarms

To disable an active alarm, either press the Power button







, or press and hold the corresponding alarm button to cancel the alarm.

Snooze

1. When the alarm sounds, press any button other than the Power button  will silence the alarm for 5 minutes. "SNOOZE" will appear on the display.
2. To adjust the silence time for the snooze timer, press and hold the Menu/Info button  to enter the menu setting.
3. Rotate the Tuning control knob  until "SNOOZE X" appears on the display, then press the Tuning control knob  to enter the setting. Rotate the Tuning control knob  to adjust the silence time from 5, 10, 15 and 20 minutes for the snooze timer.
4. To cancel the snooze timer while the alarm is suspended, press the Power button .







Sleep timer

Your radio can be set to turn off automatically after a preset time has elapsed. The Sleep Timer setting can be adjusted between 60, 45, 30, 15, 120 and 90 minutes.

1. Press and hold the Power button  to enter the Sleep Timer setting. "SLEEP XX" will show on the display.
2. Keep holding the Power button  and the Sleep Timer options will start switching on the display. Stop until the desired Sleep Timer setting appears on the display. The setting will be saved and the LCD will return to normal display.
3. Your radio will switch off automatically after the preset Sleep Timer has elapsed. The Sleep Timer icon  will show on the display indicating an active Sleep Timer.
4. To cancel the Sleep Timer function before the preset time has elapsed, simply press the Power button  to turn the unit off manually.



Loudness

You can get compensation on lower and higher frequency for your radio by adjusting the loudness function.

1. Press and hold the Menu/Info button  to enter the menu setting.
2. Rotate the Tuning control knob  until "LOUD ON" or "LOUD OFF" appears on the display. Press the Tuning control knob  to enter the setting.
3. Rotate the Tuning control knob  to choose ON to turn on the loudness function, then press the Tuning control knob  to confirm the setting.
4. To turn off the loudness function, select OFF and press the Tuning control knob  to confirm the setting.

Auxiliary input socket



Two 3.5 mm stereo Auxiliary Input sockets are provided. One is at the front of your radio (AUX IN 1); the other is located in the battery compartment (AUX IN 2).

1. Connect an external audio source (for example, iPod, MP3 or CD player) to the Auxiliary Input socket.
2. Repeatedly press and release the Source button  until AUX IN 1 or 2 is displayed.
3. Adjust the volume setting on your iPod, MP3 or CD player to ensure an adequate signal level from the player, and then use the Tuning control knob  on the radio as needed for comfortable listening.

Listening to Bluetooth® music

You need to pair your Bluetooth® device with your radio before you can auto-link to play/stream Bluetooth® music through your radio. Pairing creates a permanent "bond" so two devices can always recognize each other.

Pairing your Bluetooth® device

1. Press the Source button  to select Bluetooth® function. "BT READY" will be shown on the display and "READY" will flash with every 2 seconds interval.
2. Activate Bluetooth® on your device according to the device's user manual to allow the pairing procedure.
3. Press and release the Pair button , then "BT PAIR" will be shown on the display and it will flash with 1 second interval. You can start the search of your radio on your Bluetooth® device. Once the name of your radio is appeared on your Bluetooth® device, press the item in your Bluetooth® list.
With some old type mobiles (versions earlier than BT2.1 Bluetooth® device), you may need to input the pass code "0000".
4. Your Bluetooth® device will be linked with the radio.
5. Once connected, "BLUETOOTH" will remain on the display and the backlight will be dim-out in 10 seconds.

You can now play the music in your Bluetooth®-enabled device via your radio.

Playing Bluetooth® device which has already paired

1. Press the Source button  to select Bluetooth® function. "BT READY" will be shown on the display and "READY" will flash with every 2 seconds interval.
2. Search and link the radio on your Bluetooth® device. Some device may link with the radio automatically. You can now play the music in your Bluetooth®-enabled device via your radio.

Note:

- a) The radio can pair with 8 Bluetooth® devices at most. When you pair Bluetooth® devices more than this number, pairing history will be overwritten from the oldest pairing history.
- b) If there are 2 Bluetooth® devices searching for your radio, it will show its availability on both devices.
- c) If your Bluetooth® device is temporarily disconnected to your radio, then you need to manually reconnect your device again to the radio.
- d) If the name of your radio is appeared on your Bluetooth® device list but your device cannot connect with it, please delete the item name of your radio from your list and pair the device with your radio again following the steps described previously.
- e) The effective operation range between the radio and the paired device is approximately 10 meters (30 feet).
- f) Any obstacle between the radio and the device can reduce the operational range.

Disconnecting your Bluetooth® device

Press and hold the Pair button  for 2-3 seconds to disconnect with your Bluetooth® device. "BLUETOOTH" will disappear from the display indicating deactivation of Bluetooth®.

Charging with USB power supply port

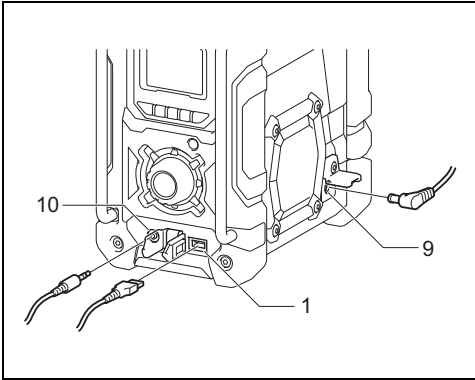

There is the USB port at the front side of the radio. You can charge USB device through the USB port.

1. Connect the USB device, such as iPod, MP3, or CD player, with USB cable available in the market.
2. Press the Power button  to switch on your radio.
3. No matter if the radio is AC powered or battery powered, the radio can charge the USB device when the radio is switched on and in FM radio mode, or BT mode, or AUX mode, which is appeared when an external audio source is connected.

Note:

You cannot charge USB devices during AM mode because radio signal reception becomes extremely poor when charging USB device.

- The maximum volume of the output power speaker will decrease when your USB is charging.
- The USB socket can provide max 1A5V of electrical current.

Important:

- Before connecting USB device to the charger, always backup your data of USB device. Otherwise your data may lose by any possibility.
- The charger may not supply power to some USB devices.
- When not using or after charging, remove the USB cable and close the cover.
- Do not connect power source to USB port. Otherwise there is risk of fire. The USB port is only intended for charging lower voltage device. Always place the cover onto the USB port when not charging the lower voltage device.
- Do not insert a nail, wire, etc. into USB power supply port. Otherwise a circuit short may cause smoke and fire.
- Do not connect this USB socket with your PC USB port, as it is highly possible that it may cause breakdown of the units.

MAINTENANCE

⚠ CAUTION:

- Never use gasoline, benzine, thinner, alcohol or the like. Discoloration, deformation or cracks may result.

Specifications:

Power Requirements

AC power adaptor DC12 V/1,200 mA, center pin positive

Battery UM-3 (AA size) x 2 for back up
Cluster battery: 7.2 V - 10.8 V
Slide battery: 10.8 V - 18 V

Frequency coverage

FM 87.50 - 108 MHz
(0.05 MHz/step)
AM (MW) 522 - 1,710 kHz
(9 kHz/step)

Bluetooth®

Bluetooth® QD ID 58625
(The Bluetooth® word mark and logos are registered trademarks owned by Bluetooth SIG, Inc.)

Bluetooth® version

4.0

Bluetooth® profiles

A2DP/SCMS-T

Transmission power

Bluetooth® specification power Class 2

Transmission range

Max. 10 m (varies according to usage conditions)

Supported codec

SBC

Compatible Bluetooth® profile

A2DP

Circuit feature

Loudspeaker

3.5 inches 8 ohm x 2

Output Power

7.2 V: 0.5 W x 2
10.8 V: 1.2 W x 2
14.4 V: 2.2 W x 2,
18 V: 3.5 W x 2

Input terminal

3.5 mm dia. (AUX IN1/AUX IN2)

Antenna system

FM: soft bended rod antenna
AM: bar antenna

Dimension (W x H x D) in mm

282 x 294 x 163

Weight

Battery cartridge	(kg)
(Without battery)	4.3
BL7010	4.4
BL1013	4.5
BL1015	
BL1020B	
BL1415	4.6
BL1415N	
BL1815	
BL1815N	
BL1820	
BL1820B	4.7
BL1040B	
BL1430	4.8
BL1430B	
BL1440	
BL1450	
BL1460B	
BL1830	4.9
BL1830B	
BL1840	
BL1840B	
BL1850	
BL1850B	
BL1860B	

Makita Europe N.V. Jan-Baptist Vinkstraat 2,
3070 Kortenberg, Belgium

Makita Corporation 3-11-8, Sumiyoshi-cho,
Anjo, Aichi 446-8502 Japan