



INSTRUCTIONS FOR:

PROFESSIONAL NO-GAS WELDER 90A 230V

MODEL NO: MIGHTYMIG90.V2

Thank you for purchasing a Sealey product. Manufactured to a high standard, this product will, if used according to these instructions and maintained properly, give you years of trouble free performance.

IMPORTANT: PLEASE READ THESE INSTRUCTIONS CAREFULLY. NOTE THE SAFE OPERATIONAL REQUIREMENTS, WARNINGS & CAUTIONS. USE THE PRODUCT CORRECTLY AND WITH CARE FOR THE PURPOSE FOR WHICH IT IS INTENDED. FAILURE TO DO SO MAY CAUSE DAMAGE AND/OR PERSONAL INJURY AND WILL INVALIDATE THE WARRANTY. KEEP THESE INSTRUCTIONS SAFE FOR FUTURE USE.



Refer to Instruction Manual



Wear a welding mask



Wear protective gloves

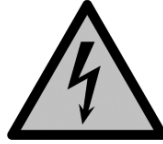

Warning: electricity

1. SAFETY

1.1. ELECTRICAL SAFETY

- WARNING!** It is the user's responsibility to read, understand and comply with the following:

You must check all electrical equipment and appliances to ensure they are safe before using. You must inspect power supply leads, plugs and all electrical connections for wear and damage. You must ensure the risk of electric shock is minimised by the installation of appropriate safety devices. An RCCB (Residual Current Circuit Breaker) should be incorporated in the main distribution board. We also recommend that an RCD (Residual Current Device) is used with all electrical products. It is particularly important to use an RCD together with portable products that are plugged into an electrical supply not protected by an RCCB. If in doubt consult a qualified electrician. You may obtain a Residual Current Device by contacting your Sealey stockist. You must also read and understand the following instructions concerning electrical safety.

- 1.1.1. The Electricity At Work Act 1989 requires all portable electrical appliances, if used on business premises, to be tested by a qualified electrician, using a Portable Appliance Tester (PAT), at regular intervals.
- 1.1.2. The Health & Safety at Work Act 1974 makes owners of electrical appliances responsible for the safe condition of the appliance, and the safety of the appliance operator. If in any doubt about electrical safety, contact a qualified electrician.
- 1.1.3. Ensure the insulation on all cables and the product itself is safe before connecting to the mains power supply. See 1.1.1. & 1.1.2. above and use a Portable Appliance Tester (PAT).
- 1.1.4. Ensure that cables are always protected against short circuit and overload.
- 1.1.5. Regularly inspect power supply leads, plugs and all electrical connections for wear and damage. Inspect power connections to ensure that none is loose.
- 1.1.6. **Important:** Ensure the voltage marked on the product is the same as the electrical power supply to be used and check that plugs are fitted with the correct capacity fuse. A 13 amp plug may require a fuse smaller than 13 amps for certain products, see fuse rating at right.
- 1.1.7. **DO NOT** pull or carry the powered appliance by its power supply lead.
- 1.1.8. **DO NOT** pull power plugs from sockets by the power cable.
- 1.1.9. **DO NOT** use worn or damaged leads, plugs or connections. Immediately replace or have repaired by a qualified electrician. A U.K. 3 pin plug must be fitted according to the following instructions. (UK only - see diagram at right).

Ensure the unit is correctly earthed via a three-pin plug.

a) Connect the green/yellow earth wire to the earth terminal.

b) Connect the brown live wire to live terminal.

c) Connect the blue neutral wire to the neutral terminal.

d) After wiring, check that there are no bare wires, that all wires have been correctly connected, that the cable external insulation extends beyond the cable restraint and that the restraint is tight.

- 1.1.10. Cable extension reels. When a cable extension reel is used it should be fully unwound before connection. A cable reel with an RCD fitted is recommended since any product which is plugged into the cable reel will be protected. The section of the cable on the cable reel is important and should be at least 1.5mm², but to be absolutely sure that the capacity of the cable is suitable for this product and for others that may be used in the other output sockets, we recommend the use of 2.5mm² section cable..

- WARNING!** Be very cautious if using a generator to power the welder. The generator must be self-regulating and stable with regard to voltage, wave form and frequency. The output must be greater than the power consumption of the welder. If any of these requirements is not met the electronics within the welder may be affected.

NOTE: The use of an unregulated generator may be dangerous and will invalidate the warranty on the welder.

- WARNING!** The welder may produce voltage surges in the mains supply which can damage other sensitive equipment (e.g. computers). To prevent this happening, it is recommended that the welder is connected to a power supply that does not feed any sensitive equipment.

1.2. GENERAL SAFETY

- DANGER!** Unplug the welder from the mains power supply before performing maintenance or service.

✓ Keep the welder and cables in good working order and condition. Take immediate action to repair or replace damaged parts.

✓ Use genuine parts and accessories only. Unapproved parts may be dangerous and will invalidate the warranty.

✓ Use an air hose to regularly blow out any dirt from the liner and keep the welder clean for best and safest performance.

✓ Check and spray the gas cup and contact tip regularly with anti-spatter spray, available from your Sealey stockist.

✓ Locate welder in a suitable work area. Ensure that the area has adequate ventilation as welding fumes are harmful.

✓ Keep work area clean, tidy and free from unrelated materials. Also ensure the working area has adequate lighting and that a fire extinguisher is at hand.

- WARNING!** Use welding head shield to protect eyes and avoid exposing skin to ultraviolet rays given off by electric arc. Wear safety welding gauntlets.

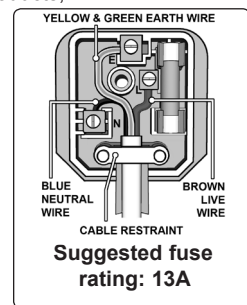

- ✓ Remove ill fitting clothing, remove ties, watches, rings and other loose jewellery and contain long hair.
- ✓ Ensure the workpiece is correctly secured before welding.
- ✓ Avoid unintentional contact with the workpiece. Accidental or uncontrolled use of the torch may be dangerous and will wear the nozzle.
- ✓ Keep unauthorised persons away from the work area. Any persons working within the area must wear a protective head shield and gloves.
- ✓ Operators must receive adequate training before using the welder.
- ✓ Stand correctly keeping a good footing and balance, ensure the floor is not slippery and wear non-slip shoes.
- X **DO NOT** operate the welder if it or the cables are damaged and **DO NOT** attempt to fit any unapproved torches or other components to the welder.
- X **DO NOT** get welder wet or use in damp or wet locations or areas where there is condensation.
- ▲ **DANGER! DO NOT weld near flammable solids, liquids or gases and DO NOT weld containers or pipes which have held flammable materials. Avoid welding materials which have been cleaned with chlorinated solvents or welding near such solvents.**
- X **DO NOT** stand welder on a metal workbench, car bodywork or similar.
- X **DO NOT** touch any live metal parts of the torch or electrode while the machine is switched on.
- X **DO NOT** pull the welder by the cable, or the torch. Protect cables from sharp or abrasive items. **DO NOT** bend, strain or stand on cables or leads. Protect from heat. Long lengths of slack must be gathered and neatly coiled. **DO NOT** place cables where they endanger others.
- X **DO NOT** touch the torch or workpiece immediately after welding as they will be very hot. Allow to cool.
- X **DO NOT** operate welder while under the influence of drugs, alcohol or intoxicating medication, or if tired.
- ✓ When not in use store the welder in a safe, dry, childproof area.

2. INTRODUCTION & SPECIFICATION

IMPORTANT: These instructions contain the information you require to prepare your machine for welding, together with a maintenance and a troubleshooting section. The instructions are not intended to teach you how to weld. If you have no experience, we recommend that you seek training from an expert source. MIG welding is relatively easy, but does require a steady hand and supervised practice on scrap metal, as it is only with continued practice that you will achieve the desired results.

INTRODUCTION: Our professional range of MIGHTYMIG welders all feature a heavy-duty high output transformer and forced air cooling to maximise duty cycle performance.

MIGHTYMIG90 is supplied with a comfort grip non-live torch, 2mtr earth cable, 0.2kg flux cored wire and 0.9mm contact tip.

Model No:	MIGHTYMIG90.V2
Welding Current:	40-90A
Wire Capacity:	0.9kg
Duty Cycle:	60% @ 45A, 10% @ 90A
Cooling System:	Forced Air
Gas Type:	N/A
Torch:	2mtr Non-live
Supply:	230V
Absorbed Power:	3kW
Case Size:	Compact
Weight:	12.7kg
Gasless Consumables	
Flux Cored Wire (0.9kg x Ø0.9mm)	TG100/1
Replacement Tips 1mm (pack of 5):	TG100/2

3. PREPARATION

3.1. Fitting a reel of wire:

- 3.1.1. Push the lock button back to release the lid (fig.1)
- 3.1.2. Rotate the wing nut (fig.2.5) anti-clockwise and remove it from the threaded spindle together with the pressure disc (fig.2.4). Leave the spring (fig.2.1) on the spindle (fig.2.2).
- 3.1.3. Place the wire reel (fig.2.3) over the spindle and down onto the spring ensuring that the wire will withdraw from the spool in a forwards direction and on the same side of the compartment as the wire feed unit.
- 3.1.4. Push down lightly on the top of the reel of wire and screw the pressure disc (fig.2.4) onto the end of the spindle and down onto the top of the wire reel. The reel take off pressure should be set to provide slight friction to prevent overrun where loose coils of wire form on the reel. **DO NOT** overtighten the pressure disc. Lock the position of the pressure disc by screwing the wing nut (fig.2.5) down on top of it.
- 3.1.5. Turn the knob on the wire lock screw (fig.1.1) anti-clockwise and lift it up and away from the pressure roller bracket (fig.1.2). Swing the pressure roller bracket away from the drive roller.
- 3.1.6. Release the wire from the spool (do not allow wire to uncoil) and straighten 40-50mm of wire and push gently through the flexible plastic guide (fig.1.4) and through the 0.9mm groove in the feed roller (fig.1.3) and into the torch liner (fig.3).
- 3.1.7. Close the pressure roller bracket onto the grooved drive wheel and swing down the wire lock screw to lock it in place (fig.4). See section 3.2 regarding wire tension.

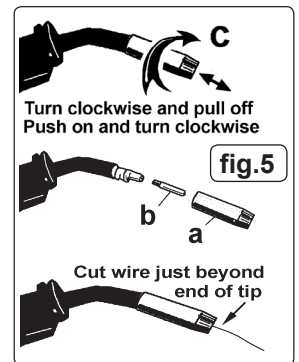
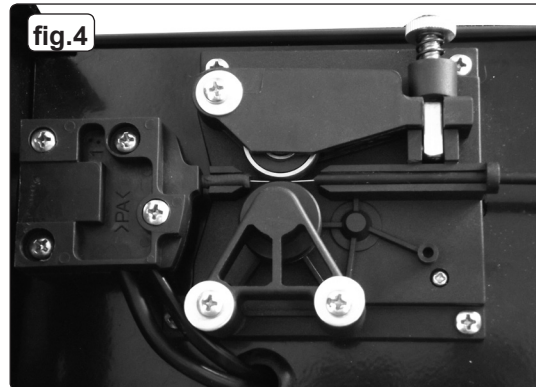
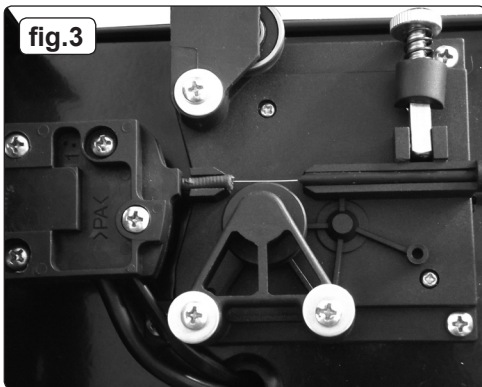
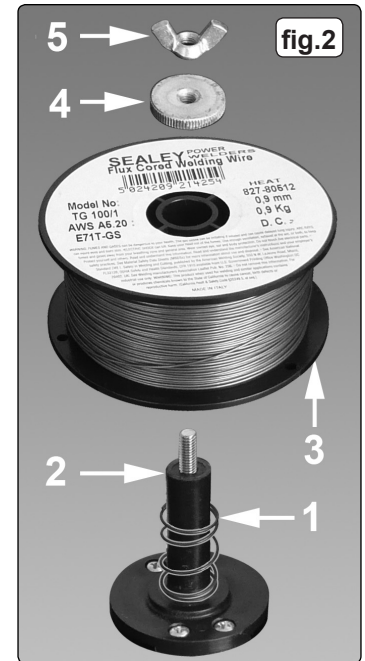
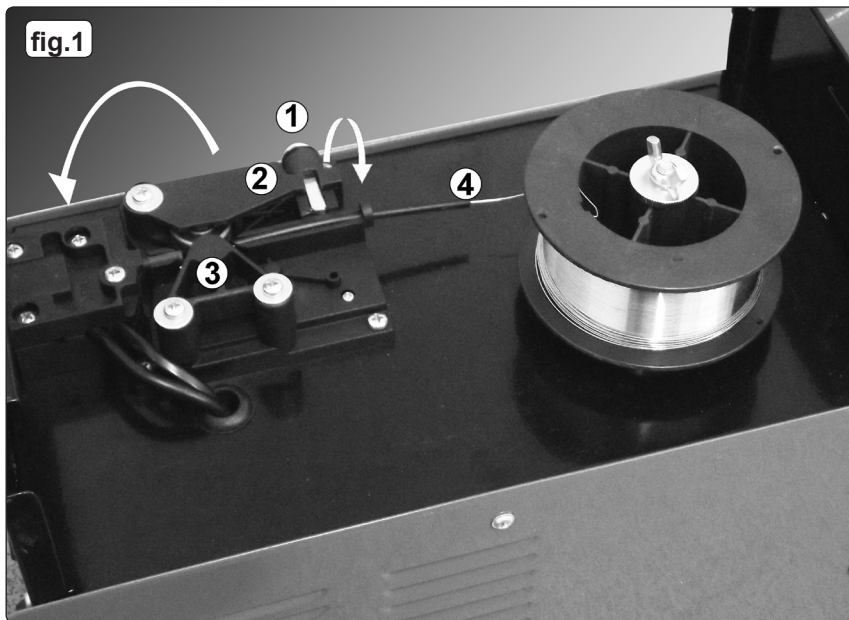

3.1.8. **Feeding the wire through to the torch.** (fig.5) Remove gas cup (a) and contact tip (b) from end of torch as follows:

- a) Take torch in left hand with the torch tip facing to the right.
- b) Grasp gas cup firmly in your right hand.
- c) Turn gas cup clockwise only and pull cup out to the right.

WARNING! do not turn gas cup anti-clockwise, as this will damage internal spring.

- d) Unscrew the copper contact tip (right hand thread) to remove.

3.1.9. Check welder is switched OFF and that the earth clamp is away from the torch tip. Connect the welder to the mains power supply and set the voltage switch to MIN.

3.1.10. Set the wire speed knob to position 5 or 6. Keep the torch cable as straight as possible and press the torch switch. The wire will feed through the torch.

3.1.11. When wire has fed through, switch welder off, **unplug from mains.**

- a) Take torch in left hand, slide the contact tip over the wire and screw it back into place.
- b) Grasp gas cup in right hand, push onto torch head and turn clockwise only.

WARNING! do not turn gas cup anti-clockwise, as this will damage internal spring.

- c) Cut wire so that it is just protruding from the cup.

3.2. Setting wire tension.

IMPORTANT: Set the correct tension, too little or too much tension will cause wire feed problems and result in a poor weld.

3.2.1. Correct tension between the rollers is checked by slowing down the wire between gloved fingers. If the pressure roller skids the tension is correct. Try to use the lowest tension possible as too high a tension will deform the wire. When welding has been completed allow the welder to cool before storing in a safe, dry place.

Note: Damaged torches and cables are not covered under warranty.

3.3. Assembling welding mask

- 3.3.1. Fold the mask body (fig.6.1) inwards until the pins (fig.6.2) line up with the holes and press together.
- 3.3.2. Secure the lens retaining clips (fig.6.3) with the pins (fig.6.4)
- 3.3.3. Open the lens retaining clips, lower the lens assembly (clear glass should be outermost) into the aperture and secure by turning the lens retaining clips through 180°.
- 3.3.4. Secure the handle (fig.6.6) to the body by means of the three screws (fig.6.7)

3.4. Shoulder strap.

Fit the shoulder strap to the locations at the front and rear of the welder casing.



4. WELDING PRINCIPLES

IMPORTANT: These instructions are not intended to teach you how to weld. If you have no experience, we recommend that you seek training from an expert source. MIG welding is relatively easy, but does require a steady hand and supervised practice on scrap metal, as it is only with continued practice that you will achieve the desired results.

4.1. MIG/MAG welding:

Welding wire is automatically fed through an insulated liner to the tip of the torch. The torch consists of a switch, liner, and control cable. The switch activates the wire feed roller. Releasing the switch stops wire feed. The weld current is transferred to the electrode (the wire) from the contact tip at the torch end. The current to the electrode is set using the rocker switch on the front of the control panel. Wire speed must be adjusted according to current output using the rotary control positioned to the left of the control panel. The higher the current the faster the wire speed. The torch is connected to the positive side of a DC rectifier, and the negative clamp is attached to the workpiece.

4.2. Preparation for welding: **IMPORTANT! BEFORE YOU COMMENCE, MAKE SURE THE MACHINE IS SWITCHED OFF AT THE MAINS. IF WELDING A CAR, DISCONNECT THE BATTERY OR FIT AN ELECTRONIC CIRCUIT PROTECTOR. ENSURE THAT YOU READ, UNDERSTAND AND APPLY THE SAFETY INSTRUCTIONS IN SECTION 1.**

- 4.2.1. To ensure a complete circuit, the negative lead must be securely attached to the workpiece close to the weld area..Best connection is obtained by grinding the point of contact on the workpiece before connecting the clamp.
- 4.2.2. The weld area must be free of paint, rust, grease, etc.

4.3. Thermal Protection:

Should the welder become overheated owing to prolonged use beyond the stated duty cycle the thermal protection will cause the welder to cut out and the amber light on the front panel will illuminate. Wait fifteen minutes for the welder to cool down at which time it will reconnect automatically.



5. RATINGS PLATE

On the front panel of the welder is the ratings plate, giving the following data:

- 1 - The BS/EU standard relating to the safety and construction of arc welding and associated equipment.
- 2 - Single phase transformer.
- 3 - Symbol indicates welding with a continuous flow of welding wire.
- 4 - Symbol for Single-phase AC supply.
- 5 - Rating of internal protection provided by casing.
- 6 - Output
 - U_0 Rated minimum and maximum no load voltage.
 - I_2, U_2 Current and corresponding voltage.
 - X Welding ratio based on a 10 minute cycle.
 - 20% indicates 2 minutes welding and 8 minutes rest,
 - 100% would indicate continuous welding.
- 7 - Mains Supply
 - U_1 Rated supply voltage and frequency.
 - $I_{1,max}$ Maximum current.
 - $I_{1,eff}$ Maximum effective current.
- 8 - Welding current range.
- 9 - Serial Number. Specifically identifies each welder.

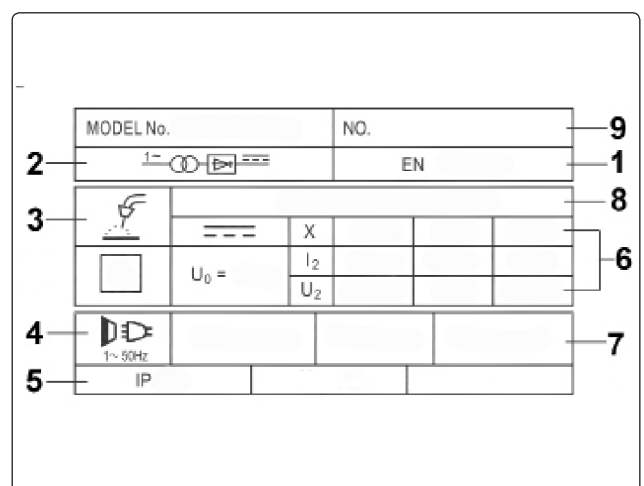

6. MAINTENANCE

▲ **DANGER! Unplug the welder from the mains power supply before performing maintenance or service.**

6.1. Wire feed unit:

6.1.1 Check the wire feed unit at regular intervals. The feed roller wire guide plays an important part in obtaining consistent results. Poor wire feed affects the weld. Clean the rollers weekly, especially the feed roller groove, removing all dust deposits.

6.2. Torch:

6.2.1 Protect the torch cable assembly from mechanical wear. Clean the liner from the machine forwards by using compressed air. If the liner is blocked it must be replaced.

6.3. Turning feed roller IMPORTANT: Turn the feed roller to suit the wire size.

6.3.1 There are two grooves on the feed roller, 0.6mm and 0.9mm. Always have the groove that is being used on the outside of the roller (uppermost). To turn the feed roller first swing the pressure roller bracket clear (see section 3.1.5.).

6.3.2 Remove the two screws holding the drive roller cover in place (arrowed in fig.8). Pull the roller off the drive spindle, turn it over and put it back on the drive spindle (fig.9) making sure that it locates on the square drive shaft. The groove size you require should now be visible on the face of the roller.

6.3.3. Replace the drive roller cover.

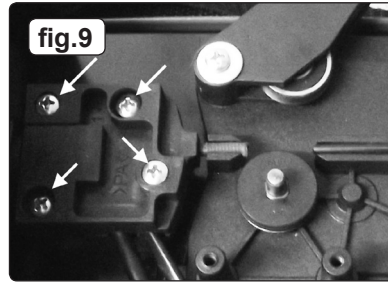
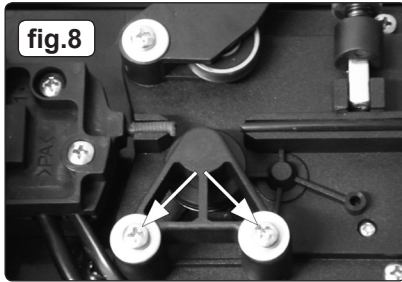

6.4. Contact tip (to remove tip follow steps in 3.1.8):

6.4.1 The contact tip is a consumable item and must be replaced when the bore becomes enlarged or oval. The contact tip must be kept free from spatter.

6.5. Gas cup (to remove cup follow steps in 3.1.8):

6.5.1 The gas cup must also be kept clean and free from spatter. Build-up of spatter inside the gas cup can cause a short circuit at the contact tip which will result in expensive machine repairs. To keep the contact tip free from spatter, we recommend the use of anti-spatter spray (MIG/722307) available from your Sealey stockist.

6.6. Replacing wire liner:

6.6.1 A worn or damaged wire liner will seriously affect the performance of the welder and should be replaced immediately. First wind the wire back onto the spool and secure it. Remove the four screws (arrowed in fig.9) securing the torch cable clamp to the wire feed unit and take off the clamp.

6.6.2 To open the torch case, unlock the locking ring (fig.10.1) by turning anticlockwise and pulling back.

6.6.3 Pull the switch housing (fig.10.4) backwards and outwards reveal the liner connector (fig.10.2).

6.6.4. To release the liner (fig.10.3), depress the liner connector and pull the liner free.

6.6.5. Pull the torch cable as straight as possible and withdraw the old liner.

6.6.6. Thread the new liner through the cable carefully. Clamp one end to the wire drive unit by means of the torch cable clamp, replacing the four screws (fig.9).

6.6.7. If necessary, cut the liner to length and insert the free end into the liner connector.

6.6.8. Close the torch case, taking care to insert the pin on the switch housing (fig.10.5) into its location.

6.6.9. Replace the locking ring by pushing onto the torch casing and turning clockwise.

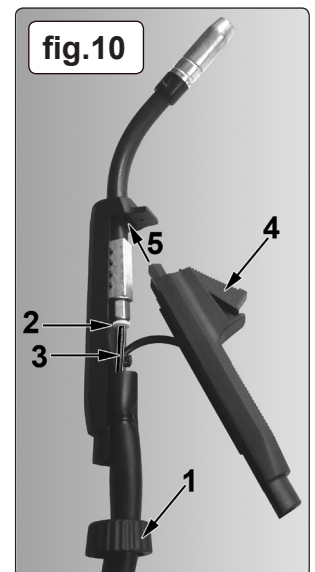

7. TROUBLESHOOTING

PROBLEM	POSSIBLE CAUSE	REMEDY
Weld current interrupted	Overheating protection activated due to overload	Protection automatically resets when transformer has cooled (approx. 15 min)
No weld current	Rectifier blown	Replace rectifier
No weld current	Bad connection between clamp and workpiece	Clean or grind contact surface and weld area
	Break in earth lead	Repair or replace earth lead
	Break in torch lead	Repair or replace
Feed motor not working	Gear damaged or worn	Replace gears
	Motor defective	Replace motor (Contact service agent)
Wire does not feed, feed roller rotates	Pressure roller improperly adjusted	Adjust tension
	Dirt, copper, dust, etc. have collected in torch liner	Clean the liner from the machine forward. Use compressed air. If too much dirt
	Gas cup (nozzle) or tip defective	Replace gas cup (nozzle) and/or tip. Check roller tension (Section 3)
	Deformed wire	Adjust roller tension
Wire feeds unevenly	Dirt, etc. in liner	Clean the liner from the machine forward using compressed air
	Gas cup (nozzle) or tip defective	Replace gas cup (nozzle) and/or tip
	Gas cup (nozzle) spattered	Clean or replace gas cup (nozzle)
	Feed roller groove clogged	Clean feed roller
	Feed roller groove deformed	Replace feed roller
	Pressure roller tension incorrect	Adjust tension
Unstable arc	Incorrect settings	Check settings
	Impurities in weld area	Clean and/or grind workpiece
	Worn or defective gas cup (nozzle)	Replace gas cup (nozzle)
Porous weld	Rusty/dirty joints	Clean or grind the workpiece
	Torch too far from, or at wrong angle to, workpiece	Gas cup to workpiece should be 8-10mm. Torch angle approx 75°
Wire sticking in gas cup (nozzle)	Worn or defective gas cup (nozzle)	Replace gas cup (nozzle)
	Wire deformed	Check roller tension
	Wire speed too slow	Increase wire speed
Irregular weld head	Torch incorrectly held	Use correct torch angle
	Wire weaving in weld pool	Check roller tension and adjust
Weld bead too narrow and raised	Weld current too low	Increase power and wire speed
	Weld speed too fast	Move torch slower and weave a little more
Weld bead too wide	Weld current too high	Increase power and wire speed
	Weld speed too slow	Move torch faster and weave less
Poor penetration	Weld current too low	Increase current and wire speed
	Arc too long	Bring torch closer to workpiece
Excessive penetration	Weld current too high	Decrease current and wire speed
	Weld speed too slow	Move torch faster
	Incorrect distance of torch to workpiece	Torch distance should be 8-10mm

Environmental Protection



Recycle unwanted materials instead of disposing of them as waste. All tools, accessories and packaging should be sorted, taken to a recycling centre and disposed of in a manner which is compatible with the environment. When the product becomes completely unserviceable and requires disposal, drain off any fluids (if applicable) into approved containers and dispose of the product and the fluids according to local regulations.

WEEE Regulations



Dispose of this product at the end of its working life in compliance with the EU Directive on Waste Electrical and Electronic Equipment (WEEE). When the product is no longer required, it must be disposed of in an environmentally protective way. Contact your local solid waste authority for recycling information.

NOTE: It is our policy to improve products continually and as such we reserve the right to alter data, specifications and component parts without prior notice.

IMPORTANT: No liability is accepted for incorrect use of this product.

WARRANTY: Guarantee is 12 months from purchase date, proof of which will be required for any claim.



Sole UK Distributor, Sealey Group,
Kempson Way, Suffolk Business Park,
Bury St. Edmunds, Suffolk,
IP32 7AR



01284 757500



01284 703534



www.sealey.co.uk



sales@sealey.co.uk