



COMPRESSOR 50LTR DIRECT DRIVE 2HP/ 4PC AIR ACCESSORY KIT

MODEL NO: **SAC5020E.V3/SAC5020EPK.V2**

Thank you for purchasing a Sealey product. Manufactured to a high standard, this product will, if used according to these instructions, and properly maintained, give you years of trouble free performance.

IMPORTANT: PLEASE READ THESE INSTRUCTIONS CAREFULLY. NOTE THE SAFE OPERATIONAL REQUIREMENTS, WARNINGS & CAUTIONS. USE THE PRODUCT CORRECTLY AND WITH CARE FOR THE PURPOSE FOR WHICH IT IS INTENDED. FAILURE TO DO SO MAY CAUSE DAMAGE AND/OR PERSONAL INJURY AND WILL INVALIDATE THE WARRANTY. KEEP THESE INSTRUCTIONS SAFE FOR FUTURE USE.



Refer to instruction manual



Wear eye protection



Wear ear protection



Warning: Hot surface



Warning: Automatic start-up



Warning: Electricity



DO NOT open the air cock before an air hose is attached



Indoor use only



Ensure oil level is correct before first use

1. SAFETY

1.1. ELECTRICAL SAFETY

- WARNING!** It is the user's responsibility to check the following:
Check all electrical equipment and appliances to ensure that they are safe before using. Inspect power supply leads, plugs and all electrical connections for wear and damage. Sealey recommend that an RCD (Residual Current Device) is used with all electrical products. You may obtain an RCD by contacting your local Sealey stockist.
If the product is used in the course of business duties, it must be maintained in a safe condition and routinely PAT (Portable Appliance Test) tested.
Electrical safety information: it is important that the following information is read and understood.
- 1.1.1. Ensure that the insulation on all cables and on the appliance is safe before connecting it to the power supply.
- 1.1.2. Regularly inspect power supply cables and plugs for wear or damage and check all connections to ensure that they are secure.
- 1.1.3. **IMPORTANT:** Ensure that the voltage rating on the appliance suits the power supply to be used and that the plug is fitted with the correct fuse - see fuse rating in these instructions.
 - * **DO NOT** pull or carry the appliance by the power cable.
 - * **DO NOT** pull the plug from the socket by the cable.
 - * **DO NOT** use worn or damaged cables, plugs or connectors. Ensure that any faulty item is repaired or replaced immediately by a qualified electrician.
- 1.1.4. This product is fitted with a BS1363/A 13 Amp 3 pin plug.
If the cable or plug is damaged during use, switch the electricity supply and remove from use.
Ensure that repairs are carried out by a qualified electrician.
Replace a damaged plug with a BS1363/A 13 Amp 3 pin plug. If in doubt contact a qualified electrician.
A) Connect the GREEN/YELLOW earth wire to the earth terminal 'E'.
B) Connect the BROWN live wire to the live terminal 'L'.
C) Connect the BLUE neutral wire to the neutral terminal 'N'.
Ensure that the cable outer sheath extends inside the cable restraint and that the restraint is tight.
Sealey recommend that repairs are carried out by a qualified electrician.
- 1.1.5. Products which require more than 13 amps are supplied without a plug. Contact a qualified electrician to ensure that a suitably rated supply is available. Ensure that an industrial round pin plug and socket are fitted by a qualified electrician.
- 1.1.6. If an extension cable reel is used, ensure that it is fully unwound before connection. Use a reel that includes an RCD, an appliance will be protected by the RCD. The cable core section is important and should be at least 1.5mm². Ensure that the cable of the reel is appropriate for this product. We recommend the use of 2.5mm² core section cable.

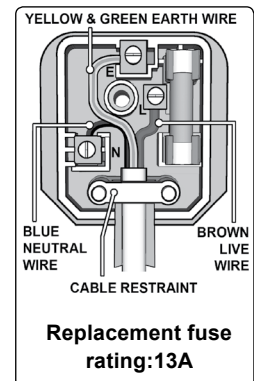

1.2. GENERAL SAFETY

- ✓ Familiarise yourself with the application and limitations of the compressor.
- ✓ Ensure the compressor is in good order and condition before use. If in any doubt **DO NOT** use the unit and contact an electrician/service agent.
- WARNING!** Compressor must only be serviced by an authorised agent. **DO NOT** tamper with, or attempt to adjust, pressure switch or safety valve.
- ✓ Before moving, or maintaining the compressor ensure it is unplugged from the mains supply and that the air tank pressure has been vented.
- ✓ Maintain the compressor in good condition and replace any damaged or worn parts. Use genuine parts only. Unauthorised parts may be dangerous and will invalidate your warranty.
- ✓ Read the instructions relating to any accessory to be used with this compressor. Ensure the safe working pressure of any air appliance used exceeds compressors output pressure. If using a spray gun, check that the area selected for spraying is provided with an air change system/ventilation.
- ✓ Ensure the air supply valve is turned off before disconnecting the air supply hose.
- ✓ To move a transportable compressor use the handle only. Lift the compressor so that the front leg gives enough clearance for manoeuvring but maintain unit's centre of gravity in front of the wheels. **DO NOT** attempt to lift or move the compressor by any other means.
- ✓ Use the compressor in a well ventilated area and ensure it is placed on a firm surface.
- ✓ Keep tools and other items away from the compressor when it is in use, and keep area clean and clear of unnecessary items.
- ✓ Ensure the air hose is not tangled, twisted or pinched.
- ✓ Keep children and unauthorised persons away from the working area.

- ✓ Only move the compressor by the handle if portable.
 - ✗ **DO NOT** dis-assemble compressor for any reason. The unit must be checked by qualified personnel only.
 - ✗ **DO NOT** use the compressor outdoors, or in damp, or wet, locations.
 - ✗ **DO NOT** operate within the vicinity of flammable liquids, gases or solids.
 - ✗ **DO NOT** touch compressor cylinder, cylinder head or pipe from head to tank as these may be hot.
 - ✗ **DO NOT** use this product to perform a task for which it has not been designed.
 - ✗ **DO NOT** deface the certification plate attached to the compressor tank.
 - ✗ **DO NOT** cover the compressor or restrict air flow around the unit whilst operating.
 - ▲ **DANGER! DO NOT** direct the output jet of air towards people or animals.
 - ✗ **DO NOT** operate the compressor without an air filter.
 - ✗ **DO NOT** allow anyone to operate the compressor unless they have received full instructions.
 - **WARNING!** The air tank is a pressure vessel and the following safety measures apply:
 - ✗ **DO NOT** tamper with the safety valve, **DO NOT** modify or alter the tank in any way and **DO NOT** strap anything to the tank.
 - ✗ **DO NOT** subject the tank to impact, vibration or to heat and **DO NOT** allow contact with abrasives or corrosives.
 - ✓ Drain condensation from tank daily and inspect inside walls for corrosion every three months and have a detailed tank inspection carried out annually. The tank shell must not fall below the certified thickness at any point.
 - **WARNING!** If an electrical fuse blows, ensure it is replaced with an identical fuse type and rating.
 - ✓ When not in use, store the compressor carefully in a safe, dry, childproof location.
 - ✓ When the compressor is not in use it should be switched off, disconnected from the mains supply and the air drained from the tank.
 - ✗ **DO NOT** carry out any welding operations on any pressurised parts of the vessel.
- 1.3. INSPECTION OF PRESSURE TANK BOTH INTERNAL AND EXTERNAL**
- 1.3.1. Under the **Pressure Systems Safety Regulations 2000** it is the responsibility of the owner of the compressor to initiate a system of inspection that both defines the frequency of the inspection and appoints a person who has specific responsibility for carrying out the inspection.

2. INTRODUCTION

Aluminium cylinder head with cast iron cylinder gives added resistance to wear. Suitable for general purpose workshop applications. Pump head directly coupled to heavy-duty induction motor for reliable and quiet operation. Welded tank complies with latest European standards. Fitted with fully automatic pressure cut-out switch with twin gauges displaying tank and working pressures. Fitted with ASTA/BS approved non-rewirable plug.

3. SPECIFICATION

MODEL: SAC5020E.V3
 Motor output:2hp
 Voltage/phase: 230V - 1ph
 Rated supply: 13A
 Noise level: 97dB(A)
 Air displacement:6.8cfm/193ltr/m
 Maximum free air delivery:4.6cfm/130ltr/m
 Tank capacity:50ltr
 Max pressure: 116psi/8bar
 Dimensions (W x D x H): 650 x 390 x 669mm



4. ASSEMBLY

- 4.1. Remove compressor from packaging and inspect for any shortages or damage. If anything is found to be missing or damaged contact your supplier.
- 4.2. Confirm that the mains voltage corresponds with the voltage shown on the compressor data plate.
- 4.3. The compressor should be installed on a flat surface, or one that does not exceed 10° either transversely or longitudinally, (see fig.1) and should be in a position that allows good air circulation around the unit.
- 4.4. **IMPORTANT!** The compressor is supplied without oil in it. The oil is in a separate container. Remove the transit plug from the oil filler aperture, pour oil into the aperture until it has reached the correct level on the sight glass (fig.2B). Fit the oil filler/breather supplied into the aperture.
- ✗ **DO NOT** attempt to run the compressor until this has been done.
- 4.5. Ensure that the air vent in the oil filler/breather is free from debris. If the air vent is blocked, pressure can build up in the crankcase causing damage to the compressor and possible personal injury.
- 4.6. Fit the air filter into the inlet port if required (fig.4).

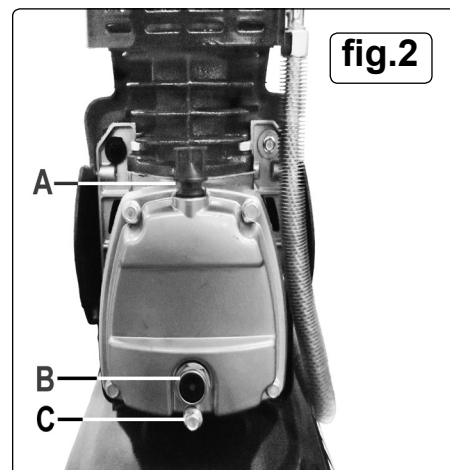
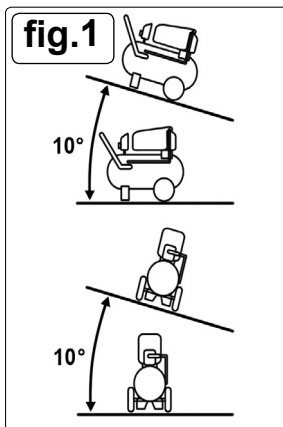

5. TOOL SELECTION

- ❑ **IMPORTANT** Take care when selecting tools for use with the compressor. Air tool manufacturers normally express the volume of air required to operate a tool in cubic feet per minute (cfm). This refers to free air delivered by the compressor ('air out') which varies according to the pressure setting. **DO NOT** confuse this with the compressor displacement which is the air taken in by the compressor ('air in'). 'Air out' is always less than 'air in' - due to losses within the compressor - and so it is important that, before choosing equipment, you study the 'Free Air Delivery' figures shown in the Specification Chart.

6. OPERATION

- ❑ **WARNING! ENSURE THAT YOU HAVE READ, UNDERSTOOD AND APPLIED SECTION 1 SAFETY INSTRUCTIONS.**
- 6.1. Make sure that the main switch (fig.3.1) is 'OFF' (down).
 - 6.2. Check the oil level by looking through the sight glass (See fig.2B).
 - 6.3. Ensure that the tank drain valve is closed (fig.5).
 - 6.4. Close the outlet pressure regulator by turning the knob clockwise (fig.3.2).
 - 6.5. Connect the air tool required to the compressor via an air line connected to the air outlet.
 - 6.6. Plug the mains cable into the mains supply and start the compressor by pulling up the main switch.
 - 6.7. Allow the pressure in the tank to rise to the maximum at which point the compressor will automatically cut out. Tank pressure is shown on the larger gauge (fig.3.5).
 - 6.8. Begin to gradually open the regulator by turning the knob until the small gauge registers the required operating pressure specified for the tool to be used. Always **adjust up** to the required pressure rather than down from a higher pressure. The required setting, once achieved, can be locked by screwing the locking ring (fig.3.3) up tight underneath the adjusting knob.
 - 6.9. You can now begin to use the tool. The compressor will operate automatically cutting in and out as required to restore the air pressure in the tank. The pressure switch (fig.3.7) stops the motor when the maximum tank pressure is reached and restarts it when pressure falls below the minimum threshold - approximately 2bar (29psi) less than the maximum pressure.
NOTE:
 - a) If the motor does not cut in and out, but runs continuously when using an air appliance, the capacity of the compressor may be too small for the appliance.
 - b) The main gauge (fig.3.5) indicates the pressure inside the main tank, **NOT** the pressure supplied to the air equipment, which is shown on the smaller gauge (fig.3.4). Should the pressure in the main tank exceed the pre-set switch (fig.3.7) maximum, the safety valve (fig.3.6) will activate.
- ❑ **WARNING!** For this reason **DO NOT** tamper with, or adjust, the switch or the safety valve.
When the compressor is not being used set the regulated pressure to zero so as to avoid damaging the pressure regulator.
- 6.10. To stop the compressor press down the main switch (fig.3.1). When the compressor stops there will be a whistling sound as compressed air is vented from the compressor head.
 - × **DO NOT**, other than in an emergency, stop the compressor by switching off the mains power, or by pulling the plug out, as the pressure relief will not then occur and motor damage may result upon restart.
 - 6.11. When you have finished using the compressor unplug the unit from the mains power supply.
 - 6.12. Set the outlet pressure on the regulator to zero.
 - 6.13. Remove the air line and air tool.
 - 6.14. The tank must now be drained. This will release the air left in the tank and drain away condensation that may have formed within the tank. Choose a suitable location for this operation and/or make provision to collect the condensation. **Wear ear and eye protection.** Open the tank drain valve (See fig.5) slowly allowing air and moisture to bleed from the tank. After bleeding close the drain valve to prevent debris building up in the valve.
- ❑ **WARNING!** Water that is allowed to remain in the tank during storage will corrode and weaken the air tank which could cause the tank to rupture. To avoid serious injury drain the tank after each use or daily.
- 6.15. **SAFETY FEATURES**
 - 6.15.1. Thermal cut out: If the unit overheats the thermal cut out will operate and shut the unit down. Allow the unit to cool down then press the reset button, located just inside the pump cover (fig.7).

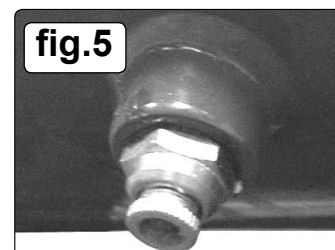
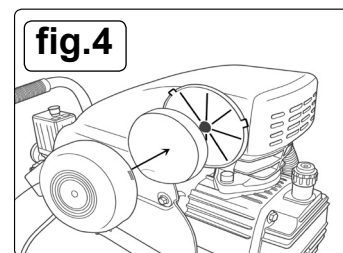
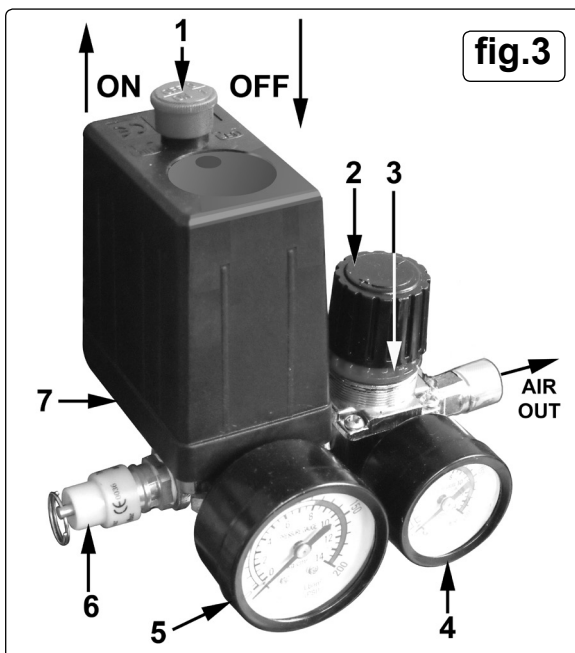

7. MAINTENANCE

- ❑ **WARNING!** Before performing any maintenance operation, switch off the compressor, disconnect from electricity supply and release all air from the tank. In order to keep the compressor in good working condition, periodical maintenance is essential.

7.1. AFTER THE FIRST 50 WORKING HOURS REPLACE THE LUBRICATING OIL - see Item 7.4.1

7.2. OPERATIONS TO BE CARRIED OUT DAILY:

- 7.2.1. Drain condensation, place a container under the valve and open the valve by turning anti-clockwise (fig.1). Retighten the valve.
- 7.2.2. Check that all nuts and bolts are tight, particularly those retaining the crankcase and cylinder head.

7.3. OPERATIONS TO BE CARRIED OUT EVERY 100 HOURS: (or more frequently, if the compressor operates in a very dusty atmosphere).

- 7.3.1. Check oil level and, if necessary, top it up.
- 7.3.2. Remove the air filter element by unscrewing the filter holder (fig.4) and prising open the holder. Clean it by blowing through with an air line at low pressure, from the clean side. Alternatively, wash it in soapy water, rinse and dry. **DO NOT** operate the compressor without the filter as foreign bodies or dust could seriously damage the pump.

- 7.3.3. Check for oil leaks.

7.4. OPERATIONS TO BE CARRIED OUT EVERY 200 HOURS:

- 7.4.1. Replace the lubricating oil. Remove the oil filler/breather and unscrew the drain bolt (fig.2B), drain the oil into a suitable container. Drain when the compressor is hot so that the oil drains rapidly and completely. Incline the compressor to ensure complete drainage. Replace the drain bolt and refill with fresh oil through the filler aperture. **DO NOT** overfill.

- 7.4.2. Replace oil filler/breather (fig.2).

7.5. RECOMMENDED OIL:

- 7.5.1. Suitable for room temperatures ranging from +5°C to +25°C: SEALEY CPO or equivalent SAE 40 compressor oil.

- 7.5.2. Room temperature below +5°C: SAE 20 compressor oil.

- ❑ **WARNING! Never mix different oils and DO NOT use non-detergent/low quality oils as the compressor may be damaged.**

- 7.5.3. Dispose of waste oil only in accordance with local authority requirements.

- 7.5.4. Check the automatic cut-out at maximum pressure and the automatic cut-in at 2 bar below that.

7.6. OPERATIONS TO BE CARRIED OUT EVERY 500 HOURS:

- 7.6.1. Replace air filter.

- 7.6.2. Check all tube fittings and electrical connections.

IMPORTANT! Failure to carry out maintenance tasks may invalidate the warranty on your compressor.

- ❑ **WARNING - Air contaminants taken into the compressor will affect optimum performance. Example: Body filler dust or paint overspray will clog the pump intake filter and may cause internal damage to pump/motor components.**

NOTE: Any parts damaged by any type of contamination will not be covered by warranty.

7.7. INSPECTION OF PRESSURE TANK BOTH INSIDE AND OUT

- 7.7.1. Under the PRESSURE SYSTEMS SAFETY REGULATIONS 2000 it is the responsibility of the owner of the compressor to initiate a system of inspection that both defines the frequency of the inspection and appoints a person who has specific responsibility for carrying out the inspection.

Scheduled maintenance table

Maintenance Operations	Daily	100 hrs.	200 hrs.	500 hrs.
Drain condensation	•			
Check oil level		•		
Clean intake filter		•		
Check for oil leaks		•		
Check cut-out			•	
Replace oil			•	
General cleaning of compressor			•	
Replace air filter				•
Check tube fittings and electrical connections				•

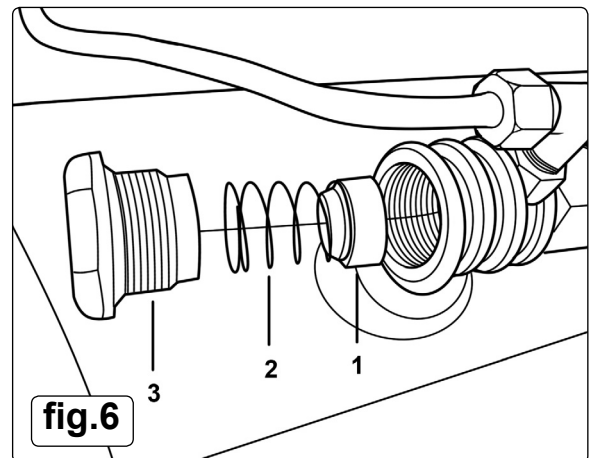

fig.6

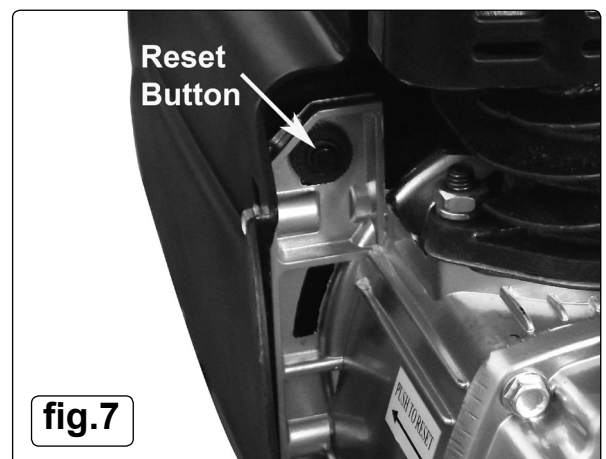

fig.7

8. TROUBLESHOOTING

FAULT	CAUSE	REMEDY
1A) Pressure drop in the tank	Air leaks at connections	Run compressor to max. pressure, switch off Brush soap solution over connections and look for bubbles. Tighten connections showing leaks If problem persists contact Authorised Service Agent
1B) Pressure drop in the tank	Air leaks from safety valve	Operate the safety valve manually by pulling on the ring. If valve continues to leak when in the closed position it should be replaced
1C) Pressure drop in the tank	Air leaks from cylinder head gasket	Check tightness of head bolts. If leak continues contact Authorised Service Agent
2) Pressure switch valve leaks when compressor is idle	Non-return valve seal defective	Empty the air tank. Referring to fig.6, remove the non-return valve cap (3), spring (2) and seal (1) Clean the seal and its seat, or if necessary replace the seal
3) Air leaks from tank body or tank welds	Internal corrosion caused by infrequent tank draining or non permitted modifications to tank	Tank could rupture or explode. Cannot be repaired DISCONTINUE USE IMMEDIATELY
4A) Motor stops and will not restart	Thermal cut out has operated	Allow unit to cool for 30 minutes, then press reset see fig.7.
4B) Motor stops and will not restart	Supply fuse has tripped	Reset fuse and restart unit. If repeated tripping occurs replace the check valve or contact authorised service agent
5) Compressor stops and does not restart	Motor failure	Contact Authorised Service Agent
6A) Compressor does not stop at max. pressure	Pressure switch fault	Contact Authorised Service Agent
6B) Compressor does not stop at max. pressure	Filter clogged Head gasket or valve fault	Replace filter element. Contact Authorised Service Agent
7) Compressor noisy with metallic knock	Bearing or piston damage	Contact Authorised Service Agent
8) Excessive moisture in discharged air	High humidity environment	Drain tank after each use

4 PC AIR ACCESSORY KIT

SUPPLIED WITH MODEL NO: **SAC5020EPK.V2**

9. SPRAY GUN SAFETY

- ❑ **WARNING!** Disconnect the spray gun from the air supply before changing accessories, servicing or performing any maintenance.
- ✓ Familiarise yourself with this products application and limitations, as well as the specific potential hazards peculiar to the spray gun. Paint cup remains pressurised after gun is disconnected from air line.
- ✗ **DO NOT** pull the trigger, but release the pressure by gently opening cup.
- ✓ Maintain the spray gun in good condition (use an authorised service agent).
- ✓ Replace or repair damaged parts. Use recommended parts only. Non authorised parts may be dangerous and will invalidate the warranty.
- ✓ Locate the spray gun in an adequate working area for its function, keep area clean and tidy and free from unrelated materials, and ensure there is adequate ventilation and lighting.
- ✓ Keep the spray gun clean for best and safest performance.
- ✓ Wear approved respiratory protection and safety eye goggles.
- ✓ Remove ill fitting clothing. Remove ties, watches, rings, and other loose jewellery, and tie back long hair.
- ✓ Keep children and unauthorised persons away from the working area.
- ✓ Avoid unintentional operation.
- ✗ **DO NOT** point spray gun at yourself, at other persons or animals.
- ✗ **DO NOT** carry the by the air hose, or pull the hose from the air supply.
- ✗ **DO NOT** use the spray gun for any purpose other than for which it is designed.
- ✗ **DO NOT** allow untrained persons to operate the spray gun.
- ✗ **DO NOT** get the spray gun wet or use in damp or wet locations or areas where there is condensation.
- ✗ **DO NOT** operate gun if any parts are missing or damaged as this may cause failure or personal injury.
- ✗ **DO NOT** direct air from the air hose at yourself or others.
- ✓ When not in use switch the spray gun off, and disconnect from the air supply.

10. TYRE INFLATOR SAFETY

- ✓ Disconnect the gauge from the air supply before changing accessories, servicing or performing any maintenance.
- ✓ Maintain the gauge in good condition (use an authorised service agent), and keep the gauge clean for best and safest performance.
- ✓ Replace or repair damaged parts. *Use recommended parts only. Unauthorised parts may be dangerous and will invalidate the warranty.*
- ✓ Locate gauge in a suitable work area, keep area clean and tidy and free from unrelated materials and ensure there is adequate lighting.
- ✓ Keep children and unauthorised persons away from the work area.
- ✗ **DO NOT** direct gauge outlet at yourself or at other persons or animals.
- ✗ **DO NOT** carry by the hose, or yank the hose from the air supply.
- ✗ **DO NOT** use the gauge for a task which it is not designed to perform.
- ✗ **DO NOT** operate the gauge when you are tired or under the influence of alcohol, drugs or intoxicating medication.
- ✗ **DO NOT** operate gauge if parts are missing or the gauge is damaged, as this may cause failure and/or personal injury.

11. AIR GUN SAFETY

- ❑ **WARNING!** Disconnect blow gun from the air supply before changing accessories, servicing or performing any maintenance.
- ✓ De-pressurise the blow gun before removing air hose from the gun.
- ✓ Maintain the blow gun in good condition (use an authorised service agent).
- ✓ Replace or repair damaged parts. Use genuine parts only. Non genuine parts may be dangerous and will invalidate the warranty.
- ✓ Keep the work area clean, uncluttered and ensure there is adequate lighting.
- ✓ Only use the blow gun for the purpose of blowing compressed air.
- ❑ **WARNING!** Always wear approved eye or face protection when operating the blow gun. Use a face or dust mask if dust is generated. Wear appropriate protective clothing.
- ✓ Maintain correct balance and footing. Ensure the floor is not slippery and wear non slip shoes.
- ✓ Remove ill fitting clothes, ties, watches, rings, other loose jewellery, and contain/tie back long hair.
- ✓ Keep children and unauthorised persons away from the working area.
- ✓ Secure non stable work piece with a clamp, vice or other adequate holding device.
- ✓ Avoid unintentional starting.
- ❑ **WARNING!** air pressure should not exceed 90psi.
- ✓ Keep air hose away from heat, oil and sharp edges. Check air hose for wear before each use, and ensure that all connections are secure.
- ✗ **DO NOT** use the blow gun for any purpose other than for which it is designed.
- ✗ **DO NOT** operate blow gun if any parts are damaged or missing as may cause failure or personal injury.
- ✗ **DO NOT** carry the by the hose, or yank the hose from the air supply.
- ✗ **DO NOT** allow untrained persons to operate the blow gun.
- ✗ **DO NOT** operate blow gun when you are tired, under influence of alcohol, drugs or intoxicating medication.
- ✗ **DO NOT** leave the blow gun operating whilst unattended.
- ✗ **DO NOT** direct air from the blow gun at yourself, others or animals.
- ✓ When not in use disconnect from the blow supply and store in a safe, dry, child proof area.

12. INTRODUCTION

Kit contains: Gravity feed spray gun, tyre inflator, air blow gun, 5m air hose 1/4" BSP

13. SPECIFICATION

Rated air pressure for all tools in the Air kit..... 90psi
Max. working pressure of PE Hose 90bar

14. AIR SUPPLY

- 14.1. Recommended hook-up fig.8.
- 14.1.1. Ensure tool's air valve (or trigger) is in the off position before connecting to the air supply.
- ❑ **WARNING!** Ensure the air supply is clean and does not exceed specification (above) while operating the tool. Too high an air pressure and/or unclean air will shorten the product life due to excessive wear, and may be dangerous causing damage and/or personal injury.
- 14.1.2. Drain the air tank daily. Water in the air line will ruin the paint finish and damage the tool.
- 14.1.3. Clean air inlet filter weekly.
- 14.1.4. Line pressure should be increased to compensate for unusually long air hoses (over 8 metres). The minimum hose diameter should be 1/4" I.D. and fittings must have the same inside dimensions.
- 14.1.5. Keep hose away from heat, oil and sharp edges. Check hose for wear, and make certain that all connections are secure.
- 14.2. **COUPLINGS**
Vibration may cause failure if a quick change coupling is connected directly to the tool. To overcome this, connect a leader hose. A quick change coupling may then be used to connect the leader hose to the air line recoil hose (fig.8).

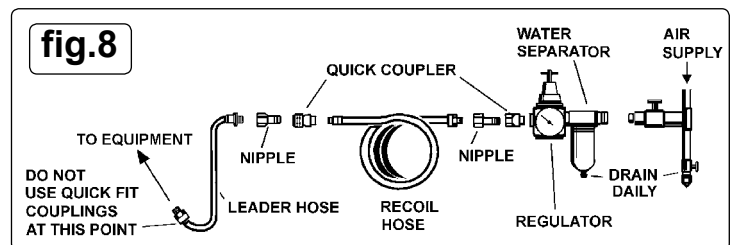

15. SPRAY GUN OPERATION

- 15.1. For best results, the gun should be held perpendicular to the surface being sprayed and moved parallel to it. Start the stroke before squeezing the trigger and release the trigger before finishing the stroke. This will enable accurate control of the gun and material refer to fig's 9 & 10 below.
- 15.2. Spray from a distance of about 6 to 10 inches (150 to 250mm) depending on the material and the atomizing pressure. The material deposited should always be even and wet. Each stroke must overlap the preceding stroke to obtain a uniform finish. To reduce over-spray and obtain maximum efficiency, spray with the lowest possible atomizing air pressure.
- 15.3. Controlling the fan spray and the fluid.
- a) Use the needle (paint) adjustment knob (fig.11.2) to adjust the amount of paint flow.
 - b) The atomizing air flow is controlled by the control knob (fig.11.1).
 - c) The volume of air input is controlled by the adjustment knob (fig.11.3).
 - d) As width of spray is increased more material must pass through the gun to obtain the same coverage on the increased area.
 - e) Turn the air nozzle (fig.11.4) to achieve a horizontal or vertical fan spray. Lock the nozzle with retaining ring (fig.11.5). The spray pattern of the gun is variable from round to flat with all patterns in between. In normal operation, the wings on the nozzle are horizontal (fig.12). This provides a vertical fan-shaped pattern which gives maximum, uniform and even coverage when moving the gun back and forth, parallel to the work surface (fig.13).

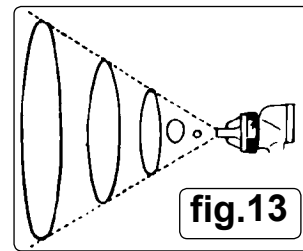
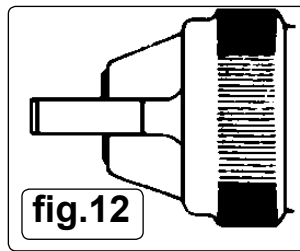
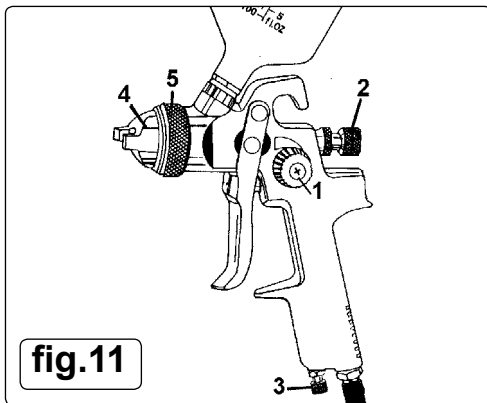
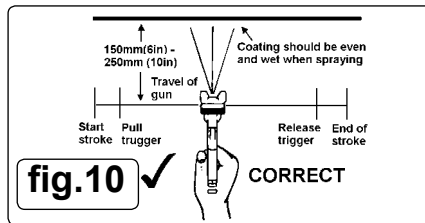
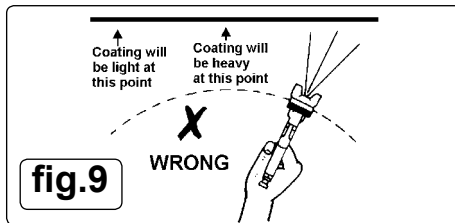

16. SPRAYGUN MAINTENANCE

FOR OPTIMUM PERFORMANCE IT IS VERY IMPORTANT TO ENSURE THE SPRAY GUN IS CORRECTLY CLEANED AFTER EACH USE.

Disconnect from the air supply before attempting any cleaning or maintenance.

16.1. CLEANING THE GUN

- 16.1.1. Flush the gun through with clean solvent.
- 16.1.2. Use a bristle brush and solvent to wash off accumulated paint.
- 16.1.3. Clean the air nozzle using a brush. Blow clean with air. Handle all nozzles carefully and do not make any alterations in the gun.
- 16.1.4. Wipe the outside of the gun with a dampened solvent rag.
- 16.1.5. If there is a need to probe the holes in the nozzles, ensure a tool that is softer than brass is utilised, under no circumstances use a metal tool, as the slightest amount of damage will adversely affect the spray pattern.
- 16.1.6. Adjust the fluid needle valve so that when the gun is triggered, air flow occurs before fluid flow.

16.2. MAINTENANCE

- 16.2.1. Take care when re-assembling. Screw parts hand tight to avoid cross-threading. If a part cannot easily be turned by hand, check that it is the correct part, or unscrew it, realign and retry. **DO NOT** use excessive force when re-assembling.
- 16.2.2. When changing the nozzle size, ensure the complete nozzle set is fitted. This consists of air cap, fluid nozzle and paint needle. Insert the fluid nozzle before paint needle.

17. TYRE INFLATOR OPERATION

17.1. ATTACH ADAPTOR TO VALVE

Push and hold the connector onto the tyre valve, squeeze the thumb clip on the connector, push the connector onto the tyre valve and release the clip.

The connector will now be locked in place.

17.2. TO INFLATE

Momentarily depress the operation lever fully, then release to display tyre pressure. When reading the pressure, hold the gauge "flat" with respect to the eye to minimise error.

Fully depress operation lever for an appropriate period. Avoid over inflation, release lever frequently to check the pressure.



WEEE REGULATIONS

Dispose of this product at the end of its working life in compliance with the EU Directive on Waste Electrical and Electronic Equipment (WEEE). When the product is no longer required, it must be disposed of in an environmentally protective way. Contact your local solid waste authority for recycling information.



ENVIRONMENT PROTECTION

Recycle unwanted materials instead of disposing of them as waste. All tools, accessories and packaging should be sorted, taken to a recycling centre and disposed of in a manner which is compatible with the environment. When the product becomes completely unserviceable and requires disposal, drain any fluids (if applicable) into approved containers and dispose of the product and fluids according to local regulations.

Note: It is our policy to continually improve products and as such we reserve the right to alter data, specifications and component parts without prior notice.

Important: No Liability is accepted for incorrect use of this product.

Warranty: Guarantee is 12 months from purchase date, proof of which is required for any claim.

Sealey Group, Kempson Way, Suffolk Business Park, Bury St Edmunds, Suffolk. IP32 7AR

01284 757500

01284 703534

sales@sealey.co.uk

www.sealey.co.uk