



INSTRUCTIONS FOR

UNDERSEAL GUN WITH CANISTER & EXTENSION PROBE

MODEL NO: **SG19.V2**

Thank you for purchasing a Sealey product. Manufactured to a high standard, this product will, if used according to these instructions, and properly maintained, give you years of trouble free performance.

IMPORTANT: PLEASE READ THESE INSTRUCTIONS CAREFULLY. NOTE THE SAFE OPERATIONAL REQUIREMENTS, WARNINGS & CAUTIONS. USE THE PRODUCT CORRECTLY AND WITH CARE FOR THE PURPOSE FOR WHICH IT IS INTENDED. FAILURE TO DO SO MAY CAUSE DAMAGE AND/OR PERSONAL INJURY AND WILL INVALIDATE THE WARRANTY. KEEP THESE INSTRUCTIONS SAFE FOR FUTURE USE.



Refer to instruction manual



Wear eye protection



Wear a mask



Wear protective gloves



Wear protective clothing

1. SAFETY

- WARNING!** Disconnect the gun from the air supply before changing accessories, servicing or performing any maintenance.
- ✓ Wear eye protection, a mask, protective clothing and gloves.
- ✓ Locate the gun in an adequate working area for its function, keep area clean and tidy and free from unrelated materials, and ensure there is adequate lighting.
- ✓ Use in a well ventilated area away from sources of ignition. Ensure underseal/rust proofing fluid manufacturer's instructions are carefully followed.
- ✓ Maintain the gun in good condition. Replace or repair damaged parts. Use recommended parts only. Non authorised parts may be dangerous and will invalidate the warranty.
- ✓ Keep the gun clean and rinse out nozzle, quick-release coupling and suction pipes with suitable solvent after use.
- WARNING!** if gun components become blocked there is a danger of excessive pressure building up in unit causing the canister to burst.
- ✓ Remove ill fitting clothing. Remove ties, watches, rings, and other loose jewellery, and contain long hair.
- ✓ Keep children and unauthorised persons away from the working area.
- ✓ When not in use ensure the air supply is turned off and the gun is disconnected. Avoid unintentional starting.
- ✗ **DO NOT** place attachments close to your face (especially eyes, ears, etc) and do not point hose at other persons or animals.
- ✗ **DO NOT** carry by the air hose, or yank the hose or the gun from the air supply.
- ✗ **DO NOT** use the gun for any purpose other than for which it is designed and do not fill with any other fluid or liquid.
- ✗ **DO NOT** operate the gun if damaged.
- ✗ **DO NOT** direct air from the air hose at yourself or others..
- ✓ When not in use disconnect from the air supply and store in a safe, dry, child proof area.

2. INTRODUCTION

Suitable for most brands of wax rust inhibitor. supplied with nozzle for surface application and 910mm flexible probe for cavities.

3. SPECIFICATION

Model no:SG19.V2
 Recommended air pressure:87-145psi (6-10bar)
 Air consumption without extension: 13.4cfm
 Air consumption with extension: 6.4cfm
 Air inlet size: 1/4" BSP
 Optional rigid probe: SG191

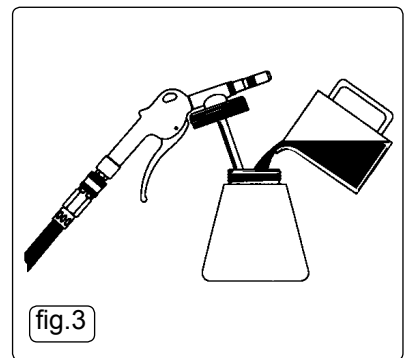
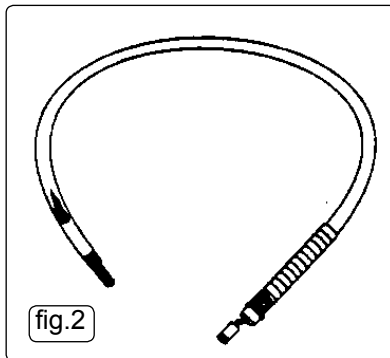
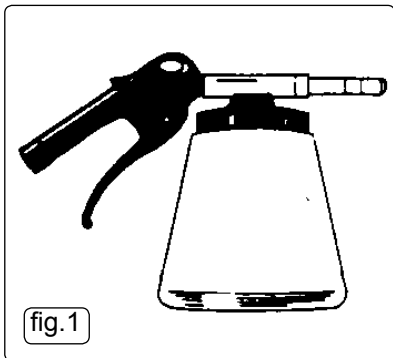

4. OPERATION

- 4.1. Follow the instructions of the rust preventative fluid/underseal carefully. Ensure that the container is shaken before use.
- 4.2. **Preparing Gun for use.**
- 4.2.1. Pour the rust preventative into the canister (fig.3) and securely screw the gun top onto canister.
- 4.2.2. Attach the end of the gun handle to the compressed air system (fig 4).
- 4.2.3. Aim the nozzle of the gun into a safe area and depress the gun trigger (fig.5A) to check and adjust the gun nozzle to the required suction and spread according to the viscosity of the fluid in the container or canister (fig.5B).
- 4.3. **Extension probes.**
- 4.3.1. The SG19 is supplied with an extension probe (fig.2) which may only be used with thin fluids. The flexible probe is for spraying thin fluids into cavities, between panels and inside doors etc.
Note: Probe is only suitable for use with thin fluids.
- 4.3.2. For spraying "hard-to-reach" areas, the SG19 may be used with the optional SG191 long reach extension probe.
- 4.3.3. To fit probe release the locking nut on the trigger nozzle (fig.6C) and remove the nozzle (D), retaining it in a safe place.
- 4.3.4. Chose the appropriate extension nozzle, and insert the sprung brass pick-up into the end of the trigger hose outlet (fig.7E) and secure with the locking nut (fig.7G).

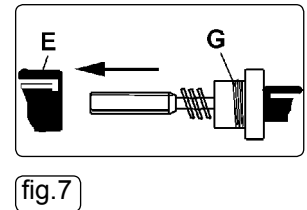
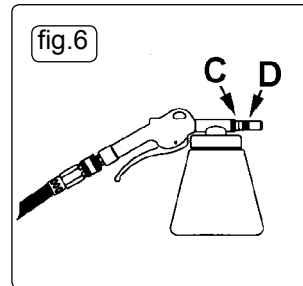
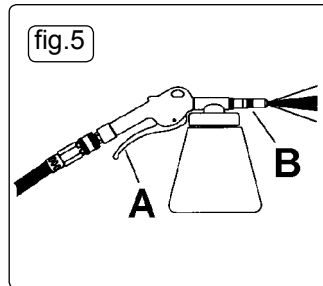
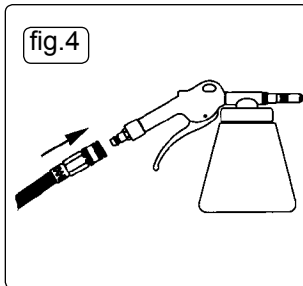

5. MAINTENANCE

- WARNING!** Ensure you remove the gun from the air supply before attempting any maintenance.
- 5.1. It is very important to keep the gun and components clean to ensure free passage of fluids in use.
- 5.2. After use clean all items especially probes with a suitable solvent and allow to dry before storage.
- WARNING! DO NOT** use any component that has become blocked as this may build up excessive air pressure and cause canister to explode.

Parts support is available for this product. To obtain a parts listing and/or diagram, please log on to www.sealey.co.uk, email sales@sealey.co.uk or telephone 01284 757500



ENVIRONMENT PROTECTION

Recycle unwanted materials instead of disposing of them as waste. All tools, accessories and packaging should be sorted, taken to a recycling centre and disposed of in a manner which is compatible with the environment. When the product becomes completely unserviceable and requires disposal, drain any fluids (if applicable) into approved containers and dispose of the product and fluids according to local regulations.



WEEE REGULATIONS

Dispose of this product at the end of its working life in compliance with the EU Directive on Waste Electrical and Electronic Equipment (WEEE). When the product is no longer required, it must be disposed of in an environmentally protective way. Contact your local solid waste authority for recycling information.

Note: It is our policy to continually improve products and as such we reserve the right to alter data, specifications and component parts without prior notice.

Important: No Liability is accepted for incorrect use of this product.

Warranty: Guarantee is 12 months from purchase date, proof of which is required for any claim.

Sealey Group, Kempson Way, Suffolk Business Park, Bury St Edmunds, Suffolk. IP32 7AR



01284 757500



01284 703534



sales@sealey.co.uk



www.sealey.co.uk