

Goliath™

T-T PUMPS®

Goliath Super 150 Automatic Sump Pump



Features

- Stainless steel casing and reinforced plastic construction
- Double mechanical seal within oil bath
- 35mm solids handling
- 0.15kW output
- 50mm discharge, which can be vertical or horizontal configuration
- Automatic as standard but can be converted to manual upon request
- Max submersion depth: 10m
- Built-in anti airlock valve

Applications

- Small water features
- Cellars & basements
- Domestic & industrial use
- Final effluent
- Nuisance water
- Marine application



Dimensions

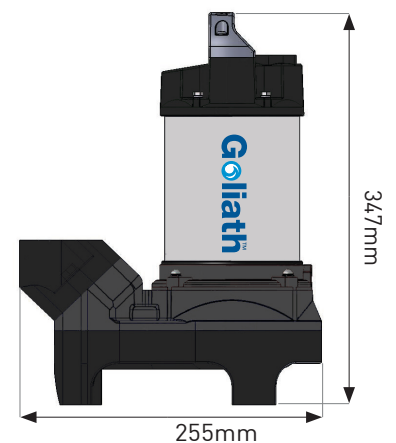
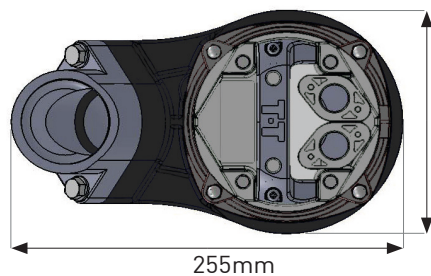

T-T Pumps Ltd., Woore, Cheshire, CW3 9RU
Tel: 01630 647200 Fax: 01630 642100
www.ttpumps.com Email: response@ttpumps.com

Pump supplied with A-float as standard.
Options available include automatic with Z floats and F floats or manual versions.



T-T PUMPS®

T-T Pumping
Stations®

T-T Controls®











T-T Service®

T-T Agricultural
& Environmental

T-T Flow
Valves

MODEL	PRODUCT CODE	VOLTAGE V	MAX FLOW l/min	FREE PASSAGE mm	MAX HEAD m	kW	OUTLET "/mm	CABLE m	WEIGHT kg
Goliath Super 230V (Manual)	PM/GOLIATHS1/1	230	250	30	6.3	0.15	2"/50mm	5	8
Goliath Super 230V (A-Float)	PM/GOLIATHS1/1-A	230	250	30	6.3	0.15	2"/50mm	5	8
Goliath Super 230V (F-Float)	PM/GOLIATHS1/1-F	230	250	30	6.3	0.15	2"/50mm	5	8
Goliath Super 230V (Z-Float)	PM/GOLIATHS1/1-Z	230	250	30	6.3	0.15	2"/50mm	5	8
Goliath Super 110V (Manual)	PM/GOLIATHS1/2	110	250	30	6.3	0.15	2"/50mm	5	8
Goliath Super 110V (A-Float)	PM/GOLIATHS1/2-A	110	250	30	6.3	0.15	2"/50mm	5	8
Goliath Super 110V (F-Float)	PM/GOLIATHS1/2-F	110	250	30	6.3	0.15	2"/50mm	5	8
Goliath Super 110V (Z-Float)	PM/GOLIATHS1/2-Z	110	250	30	6.3	0.15	2"/50mm	5	8

Recommended Sump Sizes and Float Switch Stop/Start Levels

A-FLOAT	RECOMMENDED SUMP SIZES FOR GOLIATH A-FLOAT mm			FLOAT SWITCH STOP/START LEVELS A-FLOAT (APPROX)		
	SUMP SHAPE	230V	110V		230V	110V
		310L x 280W x 410H	310L x 270W x 430H	FLOAT ACTIVATION HEIGHT	210mm	230mm
		310D x 410H	310D x 430H	FLOAT DEACTIVATION HEIGHT	80mm	90mm
		310L x 310W x 410H	310L x 310W x 430H			
Z-FLOAT	RECOMMENDED SUMP SIZES FOR GOLIATH Z-FLOAT mm			FLOAT SWITCH STOP/START LEVELS Z-FLOAT (APPROX)		
	SUMP SHAPE	230V	110V		230V	110V
		310L x 270W x 400H	310L x 270W x 420H	FLOAT ACTIVATION HEIGHT	275mm	290mm
		310D x 400H	310D x 420H	FLOAT DEACTIVATION HEIGHT	185mm	190mm
		310L x 310W x 400H	310L x 310W x 420H			
F-FLOAT	RECOMMENDED SUMP SIZES FOR GOLIATH F-FLOAT mm			FLOAT SWITCH STOP/START LEVELS F-FLOAT (APPROX)		
	SUMP SHAPE	230V	110V		230V	110V
		Not Advised Use Square	Not Advised Use Square	FLOAT ACTIVATION HEIGHT	58cm (cable length at 40cm)	62cm (cable length at 32cm)
		600D x 800H	600D x 820H	FLOAT DEACTIVATION HEIGHT	20cm (cable length at 40cm)	30cm (cable length at 32cm)
		600L x 600W x 800H	600L x 600W x 820H			